



GLEN DIMPLEX
AUSTRALIA PTY LTD

**BELLING RICHMOND 1100 DF
SERVICE MANUAL**



INDEX

<u>PRODUCT IDENTIFICATION</u>	PAGE
APPLIANCE RATING PLATE	3
<u>USER GUIDE AND INSTALLATION HANDBOOK</u>	
USER GUIDE.....	4-34
INSTALLATION INSTRUCTIONS.....	35-42
TECHNICAL DATA.....	43-45
CONVERSION DETAILS	48-48
WIRING DIAGRAM.....	50-50
PARTS LIST DB4 90 E.....	51-57
<u>REPAIR AND MAINTAINANCE</u>	
DISASSEMBLY PROCEDURES.....	58-67
COMPONANT REMOVAL.....	68-77
TECHNICAL SPECIFICATIONS.....	78-78
FAULTFINDING GUIDES.....	79-82

THIS MANUAL COVERS THE FOLLOWING MODELS :-

BELLING RICHMOND 1100 DF

PRODUCT IDENTIFICATION

Appliance rating plate location

The appliance rating plate is located on the right-hand side of the front frame and also on the rear service panel

9	10	1	8	4	3	2	8
---	----	---	---	---	---	---	---



YEAR

MONTH

NUMBER OF PRODUCTION
FOR THE MONTH

4	4	4	4	4	0	0	2	8
---	---	---	---	---	---	---	---	---

PRODUCT IDENTIFICATION CODE

It is important that during all service calls the model and serial numbers are recorded on all paper work.

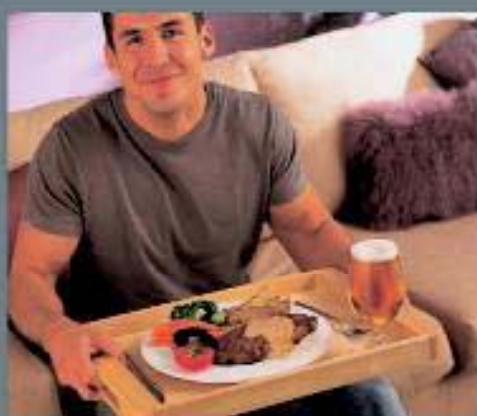
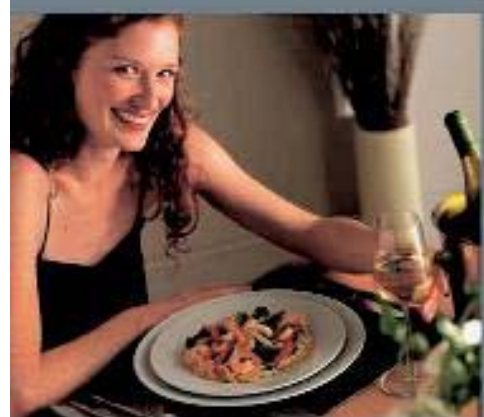

IMPORTANT NOTICE

Please note the cooling fan fitted to this appliance is an integral part of its safety and functionality.

When the appliance is installed care must be taken that the cooling fans performance is not impeded by any objects coming into contact with it. (Installation pipes, leads etc)

Care must also be taken that there is sufficient air flow at the rear of the appliance for the cooling fan to run at its optimum efficiency. (Particularly Built In appliances) See clearance dimensions in the installation section of the booklet.

During use the Appliance must never be disconnected from the Mains supply as this will seriously affect the safety and performance of the appliance, particularly in relation to surface temperatures becoming hot and gas operated parts not working efficiently.

The cooling fan is designed to run on after the control knob has been switched off to keep the front of the appliance and the controls cool until the appliance has naturally cooled itself.

Our Warranty

Should you need it

Inside the paperwork which has come with this appliance, there is a leaflet and card explaining the terms of our extended warranty and guarantee.

In order to apply for a one year guarantee, simply fill in the details on the card and post it off, this will register your appliance.

Should you wish to take out extended warranty, please fill in the details on the leaflet and post this off.

Alternatively, you can register, and apply for extended warranty on line at:

www.belling.co.uk

If your appliance is covered by the warranty and guarantee, you will not be billed for work undertaken should your appliance be faulty, terms and conditions do apply, so please read through the literature carefully.

Our Customer Care Centre can be called on:

0871 22 22 503

We aim to answer calls as quickly as possible, and in strict rotation as soon as one of our Customer Care team becomes free.

Please ensure that you have available your appliances model number and serial number, there is a space at the back of this book for recording that information.

Alternatively visit the web site.

Outside the UK and Northern Ireland, please contact your local supplier.

For Australia:

Glen Dimplex Australia,
Unit 2, 205 Abbotts Road
Dandenong South
Victoria 3175
Australia

Contents

User's Section	1 - 25
Before Using Your Cooker.	1
About Your Cooker.	2
Hob & Cooker Safety	3
Chip Pan Fires.	4
Using The Clock / Programmer	5
Setting The Programmer	7
Using Your Gas Hob.	8
Using Your Griddle.	9
Using Your Grill	10
Grilling Guide.	11
Using Your Main Oven(s)	12
Oven & Grill Functions	14
Fanned Oven Guide	15
Cooking Guide	16
Roasting Guide	17
General Baking Guide.	19
Using Your Slow Cook Oven	20
Cleaning Your Gas Hob.	22
Cleaning Your Cavities	23
Cleaning Your Appliance.	24
Cook Shop.	25
Trouble Shooting	26 - 27
Before You Call	26
Changing Light Bulbs	27
Installation Instructions	28 - 33
Installing Your Cooker	28
Technical Data	34
Service Record	36
Customer Care	Back Cover

If you smell gas:

Do not try to light any appliance. Do not touch any electrical switch.

Call the Gas Emergency Helpline at TRANSCO on: **0800 111999**

Before Using Your Cooker



Before using this appliance please make sure that you have removed all packaging and wrapping. Some of the furniture inside this appliance may have additional wrapping.



It is also advised that you turn the ovens and/or grill on for a short while, this will burn off any residues left from manufacturing. There may be a smell which accompanies this process - but this is nothing to worry about and is harmless.



We also recommend that you wash the oven shelves, the baking tray, the grill pan, and the grill pan trivet before their first use in hot soapy water, this will remove the protective oil coating.



Although every care has been taken to ensure this appliance has no burrs, or sharp edges, we recommend that you wear protective gloves when installing and moving this appliance. This will prevent any injury.



Our policy is one of constant development and improvement. Strict accuracy of illustrations and specifications cannot be guaranteed. Modification to design and material may be necessary subsequent to publication.



Please bear in mind that not all the sections inside this handbook are relevant to your appliance, but you should read carefully the sections which are relevant before installation and use. This will save you time.



Always use a registered installer for this appliance.



Environmental protection:
Stoves are committed to protecting the environment.



All packaging with this appliance is recyclable and environmentally friendly.

Please recycle whenever possible - contact your local authority for your nearest recycling centre.



This appliance is for use in a domestic kitchen only, it is not designed, or intended, for commercial use.

About Your Cooker

The illustrations below show the different cavity and hob layouts available within dual fuel ranges.

 = Programmeable oven
(see timer section)

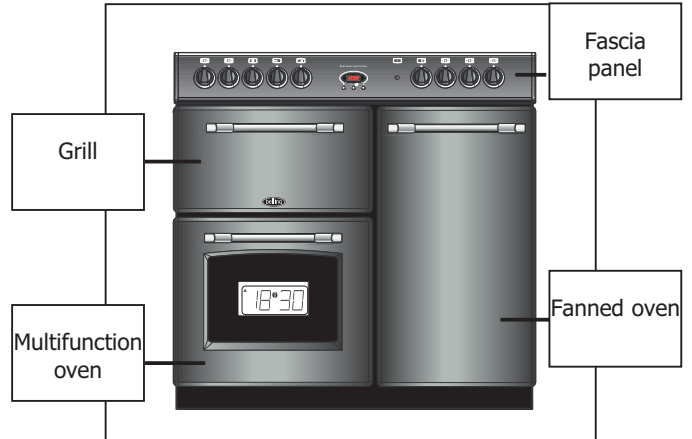
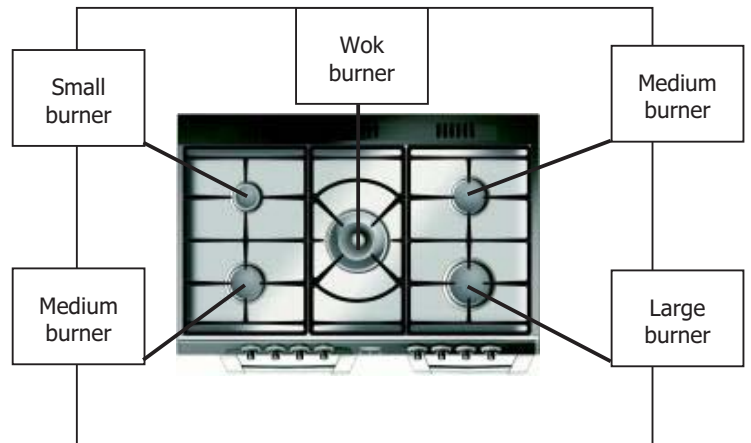
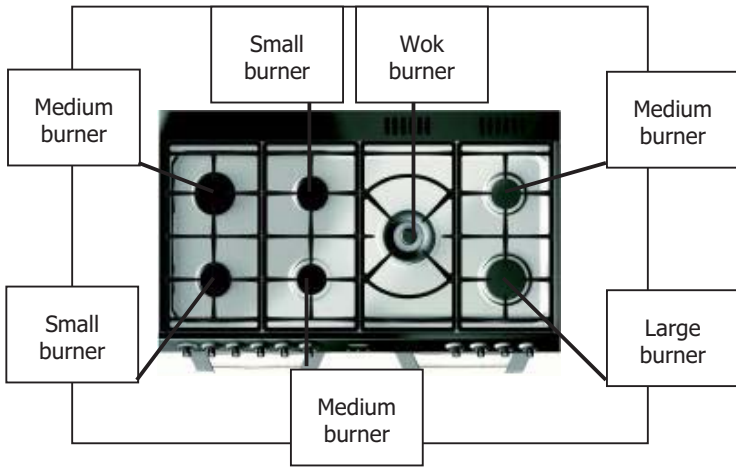

Hob & Cooker Safety

- ✓ Always ensure that pan bases are dry, and flat before using them on the hob.
- ✓ Always position pans over the centre of the burner, and turn the handles to a safe position so they cannot be knocked or grabbed.
- ✓ Always use pans which are no smaller than 100mm (4"), or larger than 250mm (10").
- ✓ Always take care when removing food from the oven as the area around the cavity may be hot.
- ✓ Always use oven gloves when handling any utensils which have been in the oven as they will be hot.
- ✓ Always make sure that the oven shelves are resting in the correct position in between two runners. Do not place the oven shelves on top of the highest runner, this will lead to spillage and injury if the baking tray, or dish falls.
- ✗ Never use double pans, rimbased pans, old or misshapen pans, or any pan which is not stable on a flat surface.
- ✗ Never leave cooking fat, or oil, unattended.
- ✗ Never use commercial simmering aids, or heat diffusers, as they create excessive heat and can damage the surface of the hob.
- ✗ Never use the hob for any other purpose than cooking food.
- ✗ Plastic cooking utensils can melt if they come into contact with a warm hob. Never leave them close to, or on top of, the hob.
- ✗ Never leave the burner alight without a pan covering it. This causes a fire hazard.
- ✗ Do not place items of the door while it is open.
- ✗ Do not wrap foil around the oven shelves, or allow it to block the flue.
- ✗ Do not drape tea towels near the oven while it is on, this will cause a fire hazard.
- ✗ Do not pull heavy items, such as turkeys, or large joints of meat, out from the oven on the shelf, as they may overbalance and fall.
- ✗ Do not use this appliance to heat anything other than food items, and do not use it for heating the room.



WARNING: Parts of the appliance may become hot while in use, always make sure that children are supervised when they are near to the appliance.

Always make sure that the burner caps, rings and pansupports are correctly placed. This will prevent pans becoming unstable while in use, and ensure an uninterrupted gas flow.



Call Customer Care for a service engineers visit if:

- You find over a period of time that the gas oven becomes hotter at a particular temperature - the thermostat may need replacing.
- The cooling fan fails to work.

Chip Pan Fires

What causes a chip pan fire?

- Chip pan fires start when oil or fat overheats and catches fire, or when oil or fat spills on to the cooker because the pan has been filled too high.
- They can also start when wet chips are put into hot oil, making it bubble up and over flow.

Preventing a chip pan fire

- Never fill the pan more than a third full with oil or fat.
- Never leave the pan alone with the heat on - even for a few seconds.
- Dry chips before putting them in the pan.
- Never put chips in the pan if the oil has started smoking. Turn off the heat and leave the oil to cool down, or else it could catch fire.

In the event of a chip pan fire





- If your chip pan does catch fire - don't panic, and don't move the pan. Serious burns are often caused by picking up the pan and running outside with it.
- If it is safe to do so, and you don't have to reach across the pan, turn off the heat.
- Never throw water, or use a fire extinguisher.
- If you can, drape a damp cloth or towel over the pan to smother the flames.
- Leave the pan to cool down for at least half an hour.
- If you can't control the fire yourself, close the door, get out and tell everybody else to get out.
- Call the fire brigade. Don't go back inside whatever the reason.

Using The Programmer/Clock

Through your programmer you will be able to set the time of day, set the minute minder, and use the semi and fully automatic cooking functions. The programmer is vital to the working of your appliance, and reading this section will make sure that you get the most out of your ovens.

The programmer buttons

There are three buttons on this type of timer. The table below shows you what their symbols look like, depending on the model type, and what they do.

Symbol	Symbol	What is it?
	-	Down / Minus Used to decrease cook / end time, remove minutes from the minute minder and adjust the time of day. Also for listening to and setting the alarm tone.
	+	Up / Plus Used to increase cook / end time, add minutes to the minute minder and adjust the time of day.
	FUNCTION 	Function button Used to select the functions available on this timer. Press once for: Minute Minder. Press twice for: Cook time Press three times for: End time. How to use these functions is explained later on in this section.

Setting the time of day

- Press the Plus and Minus buttons together for a few seconds, and release.
- The '●' in between the numbers on the LED Display will begin to flash.
- While the '●' is flashing it is possible to adjust the time using the Plus and Minus buttons.
- Once the time has been set, allow approximately 30 seconds before using any of the other timer functions. This ensures that the time will remain correct.

Setting an alarm tone

There are three tones to choose from.

- Press and release the minus button.
- Once the minus button is released, the tone is selected.

What your timer symbols mean.

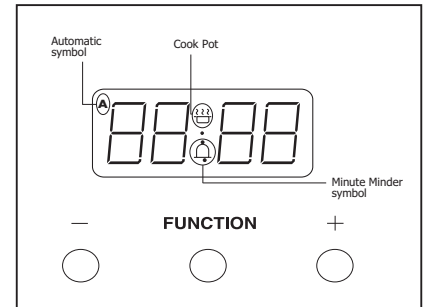

This is a 24 hour clock. Before you do anything with your appliance - you must set the correct time of day.

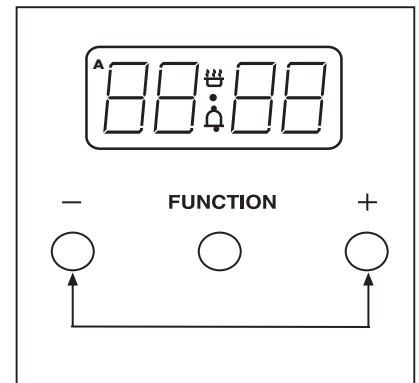

Using The Programmer/Clock

Setting the minute minder

- To set the Minute Minder, press the Function button once. The bell symbol will appear and start flashing. The flashing only lasts for 5 seconds so the time must be set within this time frame.
- Use the Plus and Minus button to set the length of time required. Once this has been done, the Minute Minder is set.
- When the desired length of time has counted down the alarm will sound. To cancel the tone, press any of the buttons.
- To cancel the Minute Minder at any time, press the Plus and Minus buttons together.

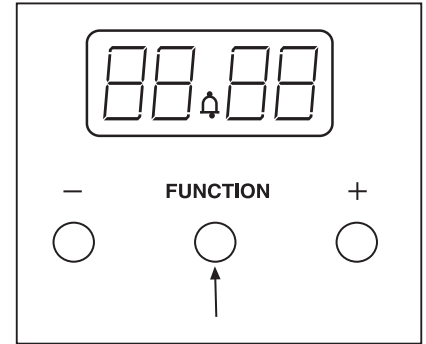

Semi - Automatic Cooking

The Duration method

Switch off after a set time period

- Press the Function button twice, which will skip past the Minute Minder.
- The display will flash the word 'dur', and the 'A' will flash on the left hand side of the display.
- Use the Plus and Minus buttons to set the length of time you want to cook for. This must be done within 5 seconds or the time of day will show again.
- Once this is done the oven will automatically switch off once the time has elapsed, and the alarm will sound. To switch off the alarm, press any button.
- To view any remaining time press the function button twice.

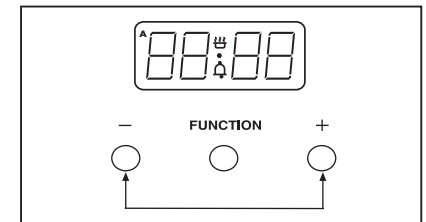
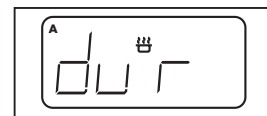
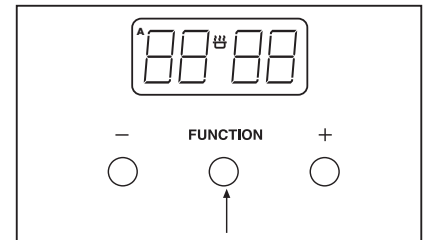

The End Time method

Switch off at a set end time

- Press the Function button three times, which will skip past the Minute Minder and the Duration programmer.
- The display will flash the word 'End' and the 'A' will flash on the left hand side of the display.
- Use the Plus and Minus buttons to select the time the oven is required to turn off.
- Once this is done the oven will turn itself off at the time you have selected. To switch off the alarm, press any button.

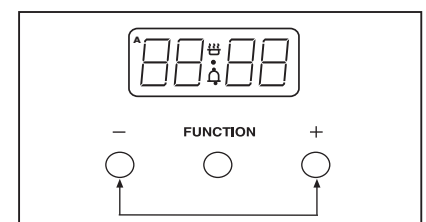
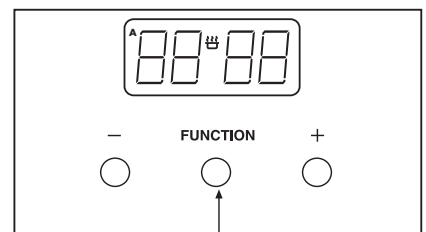

Setting the Programmer

Fully Automatic Cooking

Switch on and off automatically

This requires both the duration and the end time to be entered. The timer will work out the start time and begin cooking.

- Press the Function button twice, which will skip past the Minute Minder.
- The display will flash the word 'dur', and the 'A' will flash on the left hand side of the display.
- Use the Plus and Minus buttons to set the length of time you want to cook for. This must be done within 5 seconds or the time of day will show again.
- Press the Function button three times, which will skip past the Minute Minder and the Duration programmer.
- The display will flash the word 'End' and the 'A' will flash on the left hand side of the display.
- Use the Plus and Minus buttons to select the time the oven is required to turn off.
- Once this is done the oven will turn itself off at the time you have selected. To switch off the alarm, press any button.
- **Set the temperature of the oven and place the food inside.**
- The timer will calculate the appropriate start time.

When using the Programmer:

✓ Do:

- Familiarise yourself with the use of the programmer.
- Select foods which are as fresh and as cold as possible preferably straight from the refrigerator.
- Choose foods which are suitable for cooking from a cold start, as some dishes will be affected by being left uncooked, at room temperature.
- Make sure that meat, poultry and uncooked food are thoroughly thawed before placing them in the oven.
- Cover dishes with lids or foil.
- Try to keep the end time as close to your return as possible.

✗ Do not:

- Place warm food in the oven for delayed cooking foods must be thoroughly cooled before placing in the oven, the oven must also be cool before you start.
- Cook dishes containing left over cooked meat or poultry, or pastry dishes with wet fillings, they are not suitable!
- Over-fill dishes containing liquids.

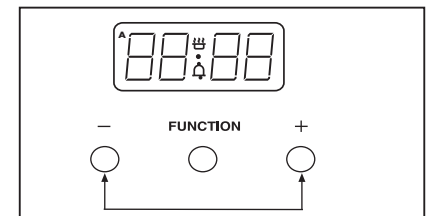
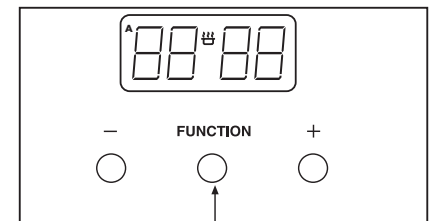
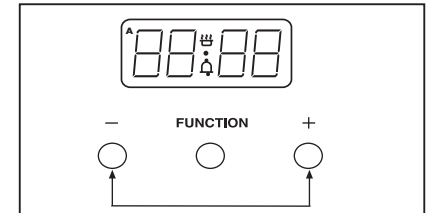
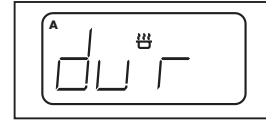
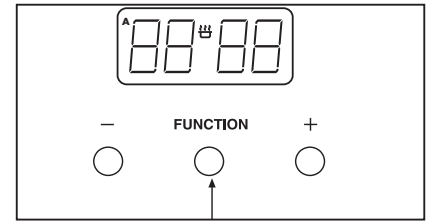

i The automatic cooking symbol will appear to show that the oven is no longer in manual mode but in automatic mode.

i **Important:** Once the oven has switched itself off please make sure you turn to oven controls to the 'off' position and set the oven to manual by pressing the Cook Time and Ready Time buttons together.

i **Important:** Remove food as soon as it is cooked.

Using Your Gas Hob

Hob Ignition

Models without thermocouples:

- To turn on, place your pan onto the pansupports above the burner you wish to use.
- Push in and turn the selected control knob anticlockwise, to the full on symbol.
- If your hob has an ignition button or switch on the fascia, press it in until your burner lights.
- If your hob has automatic ignition it will spark next to the burner when you push in the control knob.
- To simmer, turn the control knob to the small flame symbol. This will ensure that the flame is just large enough to gently heat the contents of the pan.
- To turn off, turn the control knob clockwise to the 'off' position.
- Always make sure that your pans are placed correctly on the burners as shown, and do not allow the flame to extend over the base of the pan.

Models with thermocouples:

Igniton as above, but:

- Hold the control knob in for 15 seconds. Do not hold the control knob in for any longer than 15 seconds. If the burner fails to light within this time, release the control knob and wait one minute before attempting to re-ignite.

Energy Saving

- Position pans centrally over the elements.
- Only heat the amount of liquid you need.
- Once liquids have been brought to the boil, reduce the heat setting to a simmer.
- Consider using a pressure cooker if possible.
- Vegetables in small pieces will cook quicker.
- Use a pan which is a close match to your element size.
- Smaller elements are ideal for simmering and stewing in smaller pans, while the larger elements are ideal for frying and boiling

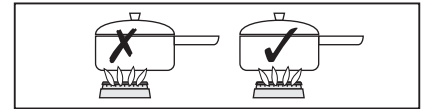
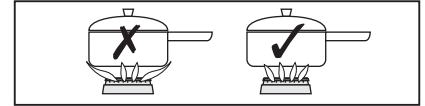

i How can I tell if my hob has thermocouples?

Picture A below: shows a burner without thermocouples.

Picture B below: shows a burner with thermocouples.

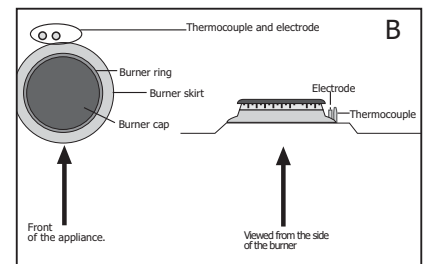
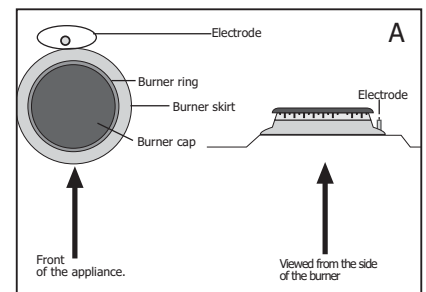

i In the event of a power failure, or the ignition not working: Push in and turn the control knob to start the gas, then hold a lighted match or taper to the burner until it lights.

i Use flat based pans which are the correct size for your burners and suitable for your hob type. We recommend the following sizes:
100mm or 4" min.
250mm or 10" max.
Smaller or larger pan sizes may lead to slower cooking times.

Using Your Griddle

- Only use the griddle which has been approved for use on this appliance. Do not use any other griddle, as this may be hazardous.
- Please read these instructions thoroughly before using the griddle for the first time.

Before using the griddle for the first time

- Wash the griddle thoroughly in hot soapy water. (see "Cleaning" section).
- Season sparingly with a minimum amount of cooking oil.
- Heat the griddle on full rate for 3 minutes. The griddle plate is now ready for use.

Using the griddle

- The griddle should only be positioned **front-to-back** over the burners indicated by the griddle symbol on the fascia panel.
- Do not use the griddle over the large burners.
- Place the griddle carefully on the pan support over the burners, using the locating feet on the underside of the griddle. Take care to avoid damage to the surface of the pan supports.
- Before cooking, preheat the griddle for 3 minutes on full rate, which is indicated on the control knobs by a large flame symbol.
- After preheating, turn the control knobs to the small flame symbol.
- The griddle is now ready for cooking.
- Do not use metal implements, as they may damage the non-stick surface.

Note:

Using a gas appliance results in the production of heat and moisture in the room in which it is installed. Always ensure that the room is well ventilated: keep natural ventilation holes open, or install a mechanical ventilation device (i.e. an extractor hood). Prolonged use of the appliance may call for additional ventilation, for example opening a window, or more effective ventilation such as increasing the level of mechanical ventilation where present.



Always make sure that children are supervised when they are near to the appliance when it is in use.



Always allow the griddle to cool completely before moving or cleaning.



About your griddle:

The griddle is made of quality cast iron, and has a non-stick cooking surface.

Regular seasoning will prolong the life of the griddle and prevent rusting. If the griddle shows signs of rust, wash and re-season.



Seasoning the griddle:

see the 'Cleaning' section of this handbook.

Using Your Grill

Before you start grilling. . . .

Before you use the grill, make sure you have placed the grill shelf in the position you need as once the grill is on you may injure yourself if you try to move the shelf.

- **Do not** close the door while the grill is in use.
- Turn the selector control knob to the heat setting you require.
- To switch off, return the control knob to the 'off' position.
- The cooling fan will come on during use, and may continue to run for some time afterwards.
- To adjust your results, you can turn the grid over, or remove it altogether.

If your grill is a dual grill:

- The dual grill uses all of the top element and is ideal for grilling large quantities of food.
- The single grill uses part of the element only, and is better suited to grill smaller amounts of food.

The grill pan

This appliance comes with a grill pan, grill pan handle and a grid.

The handle of the grill pan is detachable to allow you to remove it while the pan is in use, this stops it from getting hot.

To attach the handle:

Place the handle over the narrow edge of the grill pan and slide to the centre as shown in the diagrams.

Shelf & Grid adjustments

Speed of grilling can be adjusted by changing the shelf position or the turning the grill pan grid.

- High: For thin foods and toasting.
- Low: For thicker meat pieces.

Aluminium Foil

Never cover the grill pan or grill trivet with foil, or allow fat to build up in the grill pan, as this creates a fire hazard.

i **Warning:** Accessible parts may become hot when the grill is in use. Children should be kept away.

i Types of grill

Fixed rate grill: has a full 'on' setting and 'off'.

Variable rate grill: has adjustable heat settings 1 (low) to 8 (high) or 5 (high) - depending on the model.

Single grill: has one grill element.

Dual grill: has two grill elements which can be used together, or as a single grill.

i For best results: Pre-heat the grill for about 3 minutes.

i **Please note:** the grill pan handle is designed for sliding the grill pan into and out of the grill cavity. It is not to be used for lifted the pan.

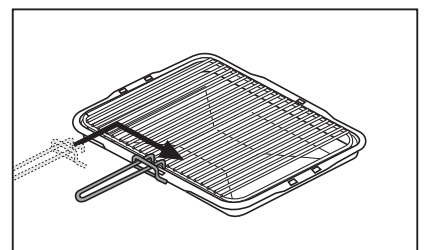
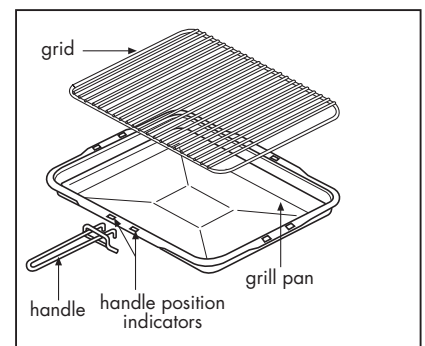

Grilling Guide

Food Type	Shelf Position	Time Approx (mins)
Bacon	5	8 - 15
Sausages	5	12 - 15
Chops ● Lamb ● Pork	4 3	10 - 15 15 - 25
Toast ● 2 rounds ● 4 rounds	5 5	1 - 2 (per side) 1 - 2 (per side)
Bread products ● Buns ● Tea cakes	4 4	1 - 2 (per side) 1 - 2 (per side)
Cheese on toast ● 2 rounds ● 4 rounds	5 5	4 - 5 4 - 5
Fish: ● fillets	2	10 - 15
Chicken: ● fillets	Depends on thickness 1 - 2	20 - 30
Beef Steaks: ● rare ● medium ● well done	5 4 4	7 - 10 10 - 15 15 - 20
Gammon Steaks	5	12 - 15

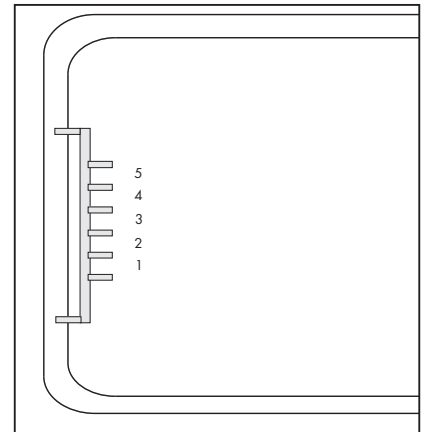

i Note: Shelf positions are counted from the bottom up.

i As with any cooking guide, all times are approximate and can be adjusted to suit personal taste.

Using Your Main Oven

The main oven may be controlled by the programmer (see The Programmer/Clock for details).

The programmer, if fitted must be set to manual before it can be used, or programmed.



Important: Never place food, or dishes on the base of the main oven, the element is here and it will cause over heating.

Switching on the multifunction oven

- Use the function control knob to select the function you wish to use - see the functions table for details.

Note: You can change function during cooking if you wish, as long as the oven is in manual mode.

- Turn the temperature control knob to the temperature you wish to use.
- The thermostat indicator will come on to show that the oven is heating, and once the temperature is achieved, it will go out.
- To switch off the main oven, simply turn the control knob back to the '●' position.
- The cooling fan will come on during use, and may continue to run for some time afterwards.

Using Your Main Oven

The main oven may be controlled by the programmer (see The Programmer/Clock for details).

The programmer, if fitted, must be set to manual before it can be used, or programmed.













Important: Never place food, or dishes on the base of the main oven, the element is here and it will cause over heating.

Switching on the fanned oven

- Use the main oven control to turn your oven on, and select your temperature.
- The thermostat indicator will come on to show that the oven is heating, and once the temperature is achieved, it will go out.
- To switch off the main oven, simply turn the control knob back to the '●' position.
- The cooling fan will come on during use, and may continue to run for some time afterwards.

Oven & Grill Functions

The chart below details all of the functions which are available. Your oven may not have all of the functions shown here.

Main Oven Function		Recommended Uses
	Base Heat Only	Used to finish off the bases of food following cooking using the conventional or fanned modes. The base heat can be used to provide additional browning for pizzas, pies and quiche. Use this function towards the end of cooking.
	Top Heat Only	The heat is ideal from browning off the tops of food as it is not as fierce as the grill following conventional or fanned cooking. Provides additional browning for dishes like Lasagna or Cauliflower cheese. Use this function towards the end of cooking.
	Conventional Oven	This function is ideal for traditional roasting. The meat is placed in the middle of the oven, roast potatoes towards the top.
	Intensive Bake	Suitable for food with a high moisture content, such as quiche, bread and cheesecake. It also eliminates the need for baking pastry blind.
	Fanned Grill	The fan allows the heat to circulate around the food. Ideal for thinner foods such as bacon, fish and gammon steaks. Foods do not require turning. Use with the oven door closed.
	Fanned Oven	The even temperature in the oven makes this function suitable for batch baking, or batch cooking foods.
	Defrost	To defrost foods, such as cream cakes/gateaux, use with the oven door closed. For cooling dishes prior to refrigeration, leave the door open.
	Dual Grill	This function cooks food from the top and is ideal for a range of food from toast to steaks. As the whole grill is working, you can cook larger quantities of food.
	Single Grill	For smaller quantities of food, but is still ideal for anything from toast to steaks.
	Base Heat with Fan	Used to cook open pies (such as mince pies) the base element ensures that the base is cooked while the fan allows the air to circulate around the filling - without being too intensive.
	Lights only	Use when the oven is switched off and cold to aid cleaning the oven cavity.

Fanned Oven Guide

- Some adjustment will have to be made to conventional cooking temperatures.
- The table below shows conventional cooking temperatures, fanned temperatures and gas marks. For optimum results using the fanned oven setting, conventional temperatures need to be converted to the fanned oven temperatures.
- For example an item which would cook at 180°C will now cook at the fanned oven temperature of 160°C.
- This is a high efficiency oven, you may notice an emission of steam when the door is opened.
- When cooking chilled or frozen foods, use the recommended cooking times and temperature on the packaging. **Always** make sure the food is piping hot throughout before serving.
- There are no zones of heat, and no flavour transfer when using a fanned oven - allowing you to cook a greater variety of foods together.
- If you are cooking on more than one shelf, you may need to slightly increase the cooking time.
- Always make sure that there is enough space between dishes, to allow food to rise, and to air to circulate.

Conventional temp (°C)	'A' Efficiency oven (°C)	Gas mark
100	100	1/4
110	110	1/4
130	120	1/2
140	130	1
150	140	2
160	150	3
180 - 190	160	4 - 5
200	170	6
220	180	7
230	190	8
250	200	9

Cooking Guide

Pre-heating

To get the best results from your oven, we recommend pre-heating for around 5 to 15 minutes before placing your dishes in. This is especially important for items which are chilled, frozen, batter based, yeast based or whisked sponges.



If you are using a fanned function, you should still pre-heat but for a shorter time.

The items in the cooking guide below are based on a pre-heated oven, but can be adjusted to take into account personal taste.

Oven and bakeware

Always use high quality trays and tins for cooking. Poor quality tins and trays can warp in the oven producing uneven results.

Never use dishes which are cracked, damaged or not oven proof as heating may lead to shattering inside the oven.

Food Type	Temp. Setting °C			Time Approx.	Shelf Position
	Conv	Fanned	Intensive		
Cakes					
Small cakes	190	160	-	15 - 25	7 & 13
Victoria sandwich	180	160	-	20 - 30	7
Semi rich fruit cake	150	125	-	2 1/2 - 3hrs	5
Christmas cake	150	125	-	2 1/2 - 3hrs	3
Puddings					
Bread & butter pudding	170	150	-	45 - 1hr	9
Fruit crumble	200	175	-	40 - 1hr	9
Miscellaneous					
Yorkshire pudding: large	220	200	200	40 - 45	11
small	220	200	200	15 - 20	12
Shortcrust pastry	200	180	180	depends on filling	top - middle

Roasting Guide

- Roasting times depend on the weight, shape and texture of the meat and personal preference. In order to calculate the roasting time, weigh the meat or poultry, **including the stuffing**, and follow the times given below.

Meat joints (including chicken) should be roasted at 180 - 200°C Conventional/ 160 - 180°C Fanned for 20 - 30 mins per 450g/1lb, plus 20 minutes on shelf position 2.

- Frozen meat must be **thoroughly** thawed before cooking. For large joints, it is advisable to thaw overnight.
- Frozen poultry must be **thoroughly** thawed before cooking. The time required depends on the size of the bird - eg: a large turkey may take up to 48 hours to thaw.
- When cooking stuffed meat or poultry, calculate the cooking time from the **total** weight of the meat **plus** the stuffing.
- Cooking joints in foil, covered roasters, lidded casseroles, or roasting bags will help to reduce meat shrinkage, give a more moist result and may reduce fat splashing. However, a slightly longer cooking times will be required, **add** 5 - 10 minutes per 450g (1lb) to the calculated cooking time. When using roasting bags do not exceed the temperatures recommended by the manufacturer, and do not allow the roasting bag to touch the sides or top of the oven.
- Use of a trivet with the roasting tin will reduce fat splashing during open roasting, and will help to keep the oven interior clean.
- The use of a roasting tin larger than that supplied is not advised, as this may impair performance and lead to extended cooking times.

Roasting Guide

Roast turkey

- Roasting turkey perfectly involves cooking two different types of meat - the delicate light breast meat, which must not be allowed to dry out, and the darker leg meat, which takes longer to cook.
- The turkey must be roasted long enough for the legs to cook, so frequent basting is necessary. The breast meat can be covered once browned.

Turkey should be roasted at 180 - 200°C Conventional/ 160 - 180°C Fanned for 20 - 30 mins per 450g/1lb, plus 20 minutes.

- The turkey can be open roasted, breast side down, for half of the cook time, and then turned over for the remainder of the cooking time.
- If the turkey is stuffed, **add** 5 minutes per 1lb to the cooking time.
- If roasting turkey covered with foil, **add** 5 minutes per 1lb to the cooking time.
- To test if the turkey is cooked, push a fine skewer into the thickest part of the thigh. If the juices run clear, the turkey is cooked. If the juices are still pink, the turkey will need longer cooking. Always make sure that the turkey is cooked properly before serving.

Turkey Roasting times.

Most Turkeys are measured by the kilogram. Timing should be calculated in either of these ways:

40 minutes per 1kg plus 10 minutes per 1/4 kg.

or

20 minutes per 1lb, plus 20 minutes.

The maximum size Turkey for this appliance is: 20lbs approximately 9kgs.

Please do not attempt to roast a Turkey larger than this, as the results cannot be guaranteed.

General Baking Guide

Trouble-shooting - Fruit Cakes

PROBLEM	POSSIBLE CAUSE
Fruit sinking to the bottom	Low oven temperature which may cause the cake to take longer to set, allowing the fruit to sink. Or, too much liquid, or raising agent. The fruit may not have been properly washed and dried.
Cake sinking / dipping in the centre	Too much raising agent in the mixture. Too hot, or too cool an oven. Or, not enough liquid or insufficient creaming.
Surface cracks	Too small a tin, or too much mixture in the tin. Too much raising agent in the mix, plus not enough liquid or insufficient creaming. The oven may be too hot.
Hard outer crust with a damp patch inside	Oven too hot, therefore the cake baked too quickly. Too much sugar, or insufficient liquid.
Burnt outside	Oven temperature too high. Oven too small for the size of cake. Insufficient protection around the tin. Cake baked on too high a shelf.
Texture with pronounced holes.	Too much raising agent. Flour unevenly mixed.
Texture too close and cake insufficiently risen.	Not enough raising agent. Not enough liquid. Too cool an oven. Insufficient creaming.
Cake crumbles when cut	Not enough liquid. Baked for too long. Not enough sugar. Too much baking agent.
Too dry	Over baking. Insufficient egg or liquid. Too much raising agent.

Trouble-shooting - Sponge Cakes

Domed top	Insufficient creaming of mixture. Cake baked on too high a shelf position, or at too high a temperature. Paper liners can cause the outer edge not to rise and the centre to peak.
Hollowed / sunken top	Too much raising agent. Oven temperature too low, or incorrect shelf position. Cake removed from oven before it's cooked. Use of soft tub margarine.
Very pale, but cooked	Oven temperature too low. Baked too low in the oven
Overflowing tin	Tin too small for the amount of mixture

Using Your Slow Cook Oven (if fitted)

Introduction

One of your oven compartments is an electric oven which provides a gentle heat suitable for slow cooking or keeping food warm. The slow cook element is positioned in the base of the lower compartment - always make sure that the cooking pot is placed centrally on the base of this compartment.

- Do not use the compartment to store food or canned items.

Cooking times

The cooking time varies according to the type of food being cooked, and experience will show how long foods should be cooked for, according to personal taste and preference.

In general foods should be cooked for at least 5 hours, and may be left up to 8 - 10 hours without spoiling if covered. Foods cooked using the slow cook oven will take about three times longer than they would in a conventional oven.

Utensils

Any oven proof utensils may be used for slow cooking - provided they have a close fitted lid.

To rectify a badly fitting lid a piece of cooking foil may be placed over the dish, under the lid.

The most useful utensils for slow cooking are the flame proof type which can be used over direct heat and for oven cooking, and are sufficiently attractive to use as serving dishes.

Benefits of Slow Cooking

Slow cooking has always been the best way to prepare hot meals with the minimum of preparation and maximum time away from the kitchen.

The advantages of slow cooking are as follows:

- Food can be left to cook unattended for several hours and will keep hot for several hours if left covered.
- Inexpensive cuts of meat become deliciously tender when slow cooked. There is also a reduction in meat shrinkage.
- Dishes such as soups, vegetables, puddings savoury dishes and preserves are also suitable for slow cooking.
- There is no topping up of steamers, steam filled kitchens or constant checking to do.

Using Your Slow Cook Oven (if fitted)

Keeping food warm

Turn the oven control knob to the on position, and place the food in the oven. If food is to be kept moist then it is important to cover the dish or plate to prevent food from drying out. This can be done using aluminium foil if the dish does not have a lid.

- **Do not** use cling film to cover food.
- Some foods are best left uncovered if you wish to keep the food dry and crisp.
- Do not add gravy to plated meals until serving.
- Carved meat should be placed on one plate and covered, adding just one tablespoon of gravy to keep it moist.
- When keeping plated meals warm it is recommended that the food is placed on hot rather than cold plates.

Slow Cooking

Turn on the slow cook oven and place the prepared cooking pot centrally on the base of the oven. Follow the guide lines for the best results.

- The maximum capacity of ovenproof dishes should be no more than 2.5 litres (4.5 pints). Please note: The more you fill the dish/pot the longer it will take to cook.
- All meat and poultry recipes need a minimum of 5 hours to cook.
- Make sure all frozen ingredients are well thawed out.
- Cut root vegetables into smaller pieces as they take longer than meat to cook. If possible they should be sauteed for 2 - 3 minutes before slow cooking.
- Ensure that root vegetables are always at the bottom of the pan immersed in the cooking liquid.
- A meat thermometer should be used when cooking pork joints and poultry. The internal temperature of the food should reach 88 °C,
- Stuffed meat or stuffed poultry should not be slow cooked. Cook any stuffing separately.
- Cover casseroles with a lid, or foil to prevent loss of moisture.
- Adjust seasoning and thickening at the end of cooking time.
- Opening the door during cooking, leads to heat loss, and will lead to increased cooking times.

Cleaning your Gas Hob

Sometimes when a hob is not working well, it is because it needs cleaning.

Enamel parts

- Use a mild cream cleaner for example 'Cif'. Stubborn marks can be removed with a soap filled pad.

Stainless steel surfaces

- Only use a clean cloth wrung out with warm, soapy water and dried off with a soft cloth. For stubborn marks use a specialist stainless steel cleaner.
- **Do not** use steam cleaners.
- Sharp implements and objects can mark the surface of stainless steel, however they do become less noticeable in time.

Cast iron parts

- Ensure the parts have fully cooled and scrape off any stubborn marks, and bits of food with a plastic, or wooden cooking implement. Rinse in warm soapy water and dry with a tea towel.
- **Do not** clean in a dishwasher.
- If you notice any rusting on your griddle, or pansupports, simply clean in warm soapy water, then re-season.

Burner caps and heads

The slots in the burner head where the flames burn should be cleared of deposits.

- Clean with a nylon brush, rinse and then dry thoroughly. There may be brownish coloured markings on your burners, these are carbon deposits or fat stains and can be removed using a soap filled pad.
- **Do not** put burners in the dishwasher or soak them. Using dishwasher powders, washing up liquids and caustic pastes can damage the burners.
- Burner caps and heads must be repositioned correctly so that they sit squarely on to the hob as shown on the the left.
- This is particularly important with stainless steel models as failure to reposition the caps correctly may result in discolouration of the stainless steel around the burners.

Painted & Plastic parts

- Only use a clean cloth wrung out in hot soapy water.



Always allow your appliance to cool down, and switch off the electricity before you clean any part of it.



Baby oil can be used to restore stainless steel finishes - but only use a few drops. Don't use cooking oils as they can contain salts which will damage the metal.



Don't use: undiluted bleaches, products containing chlorides, wire wool or abrasive cleaners on aluminium, stainless steel, or plastic/painted parts they can damage the appliance. Nylon pads can also be unsuitable



Seasoning the griddle:

Pour a drop of unsalted cooking oil onto the cooking side of the griddle, use kitchen roll to cover the griddle evenly. Olive oil is not suitable for seasoning. Regular seasoning prevents rust.

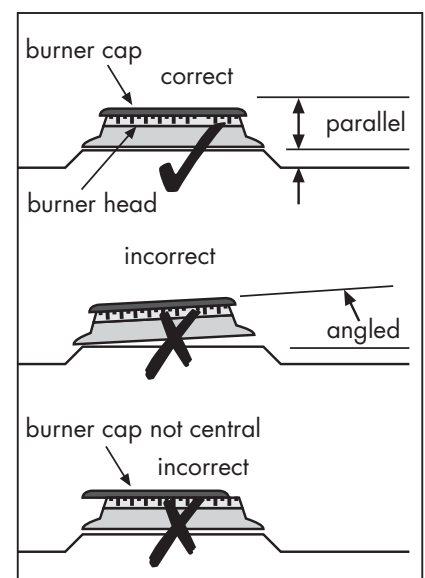

Cleaning your Cavities

Cleaning the oven cavities

- Some foods can cause fat to spit, especially if you have open roasted, this leaves the inside of the cavity greasy.
- It is important to clean the oven cavity as a build up of fat can damage the appliance and may invalidate your guarantee.

Chrome plated parts.

- Use a moist soap filled pad, or place in a dishwasher.
- Shelf runners can be removed to enable you to clean then thoroughly. Make sure they are cool to touch and then grasp the runners and slide out of their hanging holes.

Pristine enamel surfaces

- The enamel can be cleaned by wiping the surfaces with a clean cloth which has been wrung out in hot, soapy water.
- If larger splashes of fat do not readily disappear, you can use a mild cream cleaner to remove them. More stubborn marks can be removed using a soap filled pad.
- Rinse well, and allow to dry before use.

Vitreous enamel surfaces

- The enamel can be cleaned by wiping the surfaces with a clean cloth which has been wrung out in hot, soapy water.
- Stubborn marks can be cleaned using a moistened soap filled pad, or a mild cream cleaner.
- Rinse well, and allow to dry before use.



Always allow your appliance to cool down, and switch off the electricity before you clean any part of it.

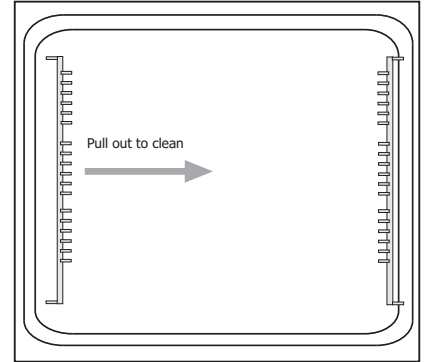

Don't use:
Caustic or abrasive cleaners, bleaches, coarse wire wool or hard impliments, these will damage your appliance.



Using a trivet while roasting meat may help to reduce fat splashes.

Cleaning your Appliance

Painted & Plastic parts

- Only use a clean cloth wrung out in hot soapy water.
- **Do not** use abrasive cleaners, such as "Cif", wire or nylon cleaning pads on these parts.

Stainless steel & Aluminium surfaces

- Only use a clean cloth wrung out in hot soapy water, and dry with a soft cloth.
- Stubborn marks can be removed using a stainless steel cleaner. Supplies can be purchased from the Customer Care Centre.
- Sharp objects can mark the surface of stainless steel, but will become less noticeable with time.
- Wipe any spillage immediately, taking care to avoid burning your hands.
- Some foods are corrosive eg; vinegar, fruit juices and especially salt - they can mark or damage the metal if they are left on the surface.

Enamel surfaces & parts

- Clean with warm, soapy water and a clean cloth.
- Dry with a soft clean towel or cloth.
- Do not use steam cleaners.

Glass parts

- Only use a clean cloth wrung out in hot soapy water, or a specialist glass cleaner.
- Rinse away any excess cleaner and dry with a soft cloth.
- Do not use abrasives or polishes as they will scratch and damage the glass.
- The inner door glass panel can be removed for cleaning but it must be replaced the right way up. If there is any writing on the glass, you must be able to read it clearly when the cavity doors are open.
- Always make sure that the glass is pushed fully into the **Stop** position.
- To remove the glass panel, open the door wide, hold the top and bottom edges and slide out.
- **Warning:** *Do not* operate the appliance without the glass panel correctly fitted.



Always allow your appliance to cool down, and switch off the electricity before you clean any part of it.



Take extra care when cleaning over symbols on fascia panels, excessive cleaning can lead to the symbols fading.



Baby oil can be used to restore stainless steel finishes - but only use a few drops. Don't use cooking oils as they can contain salts which will damage the metal.



Don't use: undiluted bleaches, products containing chlorides or abrasive cleaners on aluminium or stainless steel, they can damage the appliance.

Glass door panels

For your safety, glass door panels are made of toughened glass. This ensures that, in the unlikely event that a panel breaks, it does so into small fragments to minimise the risk of injury.

Please take care when handling, using or cleaning all glass panels, as any damage to the surfaces or edges may result in the glass breaking without warning or apparent cause at a later date.

Should any glass panel be damaged, we strongly recommend that it is replaced immediately.

Cook Shop

To order or enquire about any of these products, please call the Spares Sales team on: **0870 458 9961.**

Product description	Product code	Quantity	Where used
Rectangular carbon filters	082612620	2	Hoods
Round carbon filters	082611571	1	Hoods
Ceramic hob scraper kit	082606781	1	All ceramic glass hobs including induction.
Ceramic hob cleaner and conditioner	082606780	1	All ceramic glass hobs including induction
Sealed hotplate conditioner	082606783	1	All sealed / solid plate hobs.
Stainless steel cleaner	082606764	1	All stainless steel parts
Oven cleaner spray	082606786	1	All cookers, inside cavities and on glass.
Multi-purpose kitchen cleaner	082606782	1	General kitchen cleaner.
E-cloth	082813300	1	All cookers, for cleaning glass and stainless steel

Before you call. .

Problem?	Advice
The ignition won't work. (Gas and dual fuel models)	<ul style="list-style-type: none">● Check there is a spark when the ignition button is depressed. If there is no spark, check the electricity supply is switched on at the socket.● Check that the gas supply is switched on.● Try another appliance in the socket, if that works replace the 3 amp fuse in the cooker plug.
There's condensation on the doors.	<p>Condensation is caused by hot, moist air meeting a cooler surface (i.e. the oven door). You cannot always prevent it, but you can minimise it when it happens by doing the following:</p> <ul style="list-style-type: none">● Pre-heat the oven at a high temperature before putting food in the oven, and cover the food you are cooking wherever possible.● Whenever you can, cook wet foods at higher temperatures.● Don't leave food in the oven to cool down. <p>Automatic cooking will normally produce condensation when the oven is cooling down with food inside.</p>
There's been a power failure and the oven won't work. (models with clocks and automatic programmers)	<ul style="list-style-type: none">● Switch off the electricity supply.● When the power returns - re-set the programmer/Clock to the correct time of day. <p>This will allow you to use your appliance.</p>

Changing Light Bulbs

Warning: There is a risk of electric shock, so always make sure you have turned off and unplugged your appliance.

Not all appliances have the same number and type of bulbs. Before replacing your bulb, open the top/main oven door and see which type you have. Then use the table to help you change your bulb correctly.

Please remember that bulbs are not covered by your warranty.

Bulbs can be purchased from hardware stores (always take the old bulb with you).

No. of lamps	Bulb Location	Oven type	Instruction for changing the bulb
2 (@25W)	side	All	Wait until the oven is cool, then remove the oven shelves. Grasp the lens cover on the light fitting and pull it away from the side of the oven. Unscrew the bulb.
1 (@25W)	rear	Fanned / Multifunction	Wait until the oven is cool, then remove the shelves. The oven light is at the rear of the oven cavity. Remove the loose oven back - unscrew the 4 securing screws (one at each corner). Unscrew the lens cover (turn anticlockwise). Unscrew the bulb and replace. Replace lens cover and replace oven back.
1 (@25W)	rear	Conventional	Wait until the oven is cool, then remove the oven shelves. The oven light is at the rear of the oven cavity. Unscrew the lens cover (turn anticlockwise). Unscrew the bulb and replace. Replace lens cover.

There is no need to remove the oven back on the 90DF model.

Installing Your Cooker

Clearances

This cooker may be fitted flush to the base units of your kitchen.

- No shelf, overhang, cupboard, or cooker hood should be less than 650mm above the hob top, but please check this with the hood manufacturers instructions.
- If your appliance has a side opening door, we recommend a side clearance of 60mm to allow the oven door to fully open.
- The cooker must have a side clearance above hob level of 90mm up to a height of 400mm.
- The important dimensions are those around the appliance.

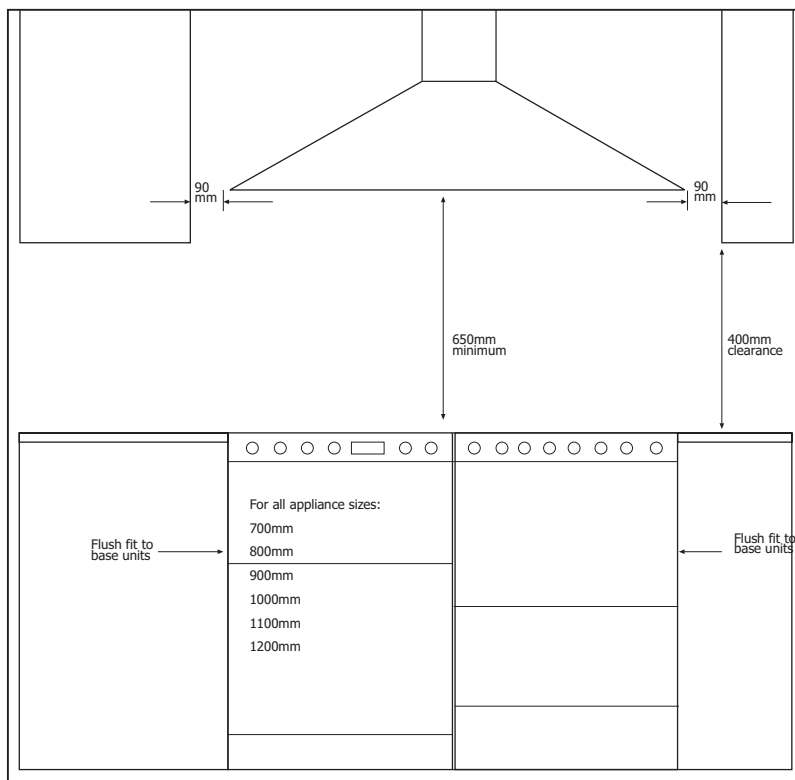

Installing Your Cooker

The information below is crucial to installing this appliance correctly and safely.

Ventilation Requirements

The room containing the appliance should have an air supply in accordance with BS 5440:Part 2.

- All rooms require an openable window, or equivalent, and some will require a permanent vent as well.
- For room volumes up to 5m³ an air vent of 100cm³ is required.
- If the room has a door which opens directly to the outside, or exceeds 10m³ - no air vent is required.
- For room volumes between 5m³ and 10m³ and air vent of 50cm² is required.
- If there are other fuel burning appliances in the same room, BS 5440:Part 2 should be consulted to determine the air vent requirements.
- This appliance must not be fitted into a bed sitting room of less than 20m³ or into a bath or shower room.

Windows and vents should not be blocked or removed without first consulting a competent engineer.

LPG only - do not install this appliance below ground level. This does not preclude installation into rooms which are basements with respect to one side of the building, but open to ground level on the opposite side.

Australian Gas Safety (Installation & Use) Regulations

This appliance must be installed by an authorised person in accordance with the manufacturers installation instructions, local gas fitting regulations, the AGA Gas Installation, the Australian Gas Installation Code AG601 / AS5601 and any other relevant statutory regulations.

Particular attention should be given to relevant requirements regarding ventilation.

Where standards have been revised - always use the most recent edition.

Failure to install appliances correctly is dangerous and could lead to prosecution.

Installing Your Cooker

The information below is crucial to installing this appliance correctly and safely.

UK Regulations & Standards

always refer to the most recent issue of the standards

- Gas Safety Regulations.
- Building Regulations - issued by the DEFRA.
- Building Standards (Scotland) (Consolidated) - issued by the Scottish Development Department.
- I.E.E. Wiring Regulations.
- Electricity at Work Regulations.
- BS 6172 Installation of Domestic Gas Cooking. For **LP Gas**, refer to BS 5482 Part 1, Part 2 or Part 3 as relevant.
- Installation and Servicing Instructions for this appliance.

For installation in countries other than the UK, the appliance must be connected in accordance with all local gas and electrical regulations.

In the Republic of Ireland installers should refer to IS 813 Domestic Gas Appliances.

Failure to install appliances correctly is dangerous and could lead to prosecution.

Installing Your Cooker

Fitting the plinth (if applicable)

- Make sure the appliance is raised to a height of 915mm or above before beginning. If the appliance is below 915mm - you can only fit the plinth cover labelled X. You can adjust the height using the feet (1) of the appliance.
If your appliance has a storage drawer at the bottom, you access the required holes through the base of the drawer after lifting the mat.
- Open the appliance doors, and loosen screw A located on bracket (2). Do not remove this screw entirely.
- Insert screw B, through slot (3) and screw into the small hole at the bottom of bracket (2).
Make sure that the plinth cover is flush to the appliance, but not over tightened.

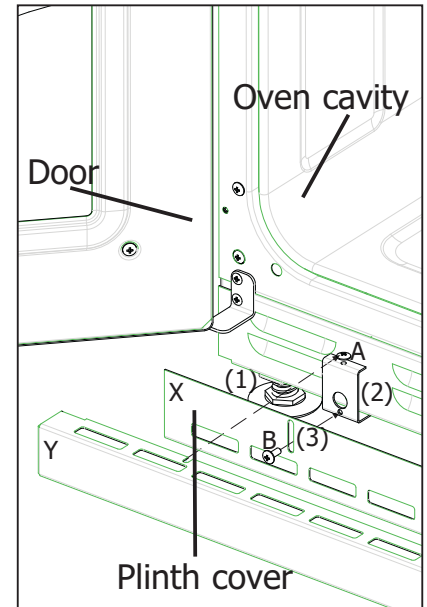

Fitting the splashback (if applicable)

- Loosley fit screw A and nut B into hole 1 at both ends of the rear surface of the appliance.
- Locate fitted screw A through the slots in both of the metal splashback plates.
- Tighten screw A and nut B.
- Now locate and tighten screw C and nut D through hole (2) at both ends of the rear surface of the appliance.
Make sure that the splashback is securely attached, but avoid over tightening.

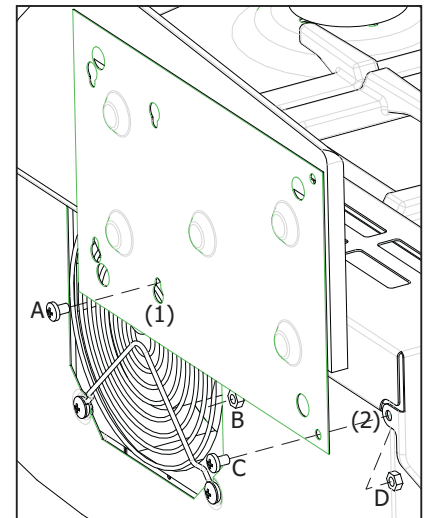

Fitting the towel rail (if applicable)

- On the towel rail there are two hole, top (A) and bottom (B), these holes have corresponding holes on the fascia at each end.
- The screw for the top hole (A), must be screwed into the supplied adaptor, whereas the remaining screw just goes through the bottom hole (B). Both screws are M6 screws. Using the allen key provided, tighten the screws making sure that the towel rail is flush to the fascia, but not over tightened.

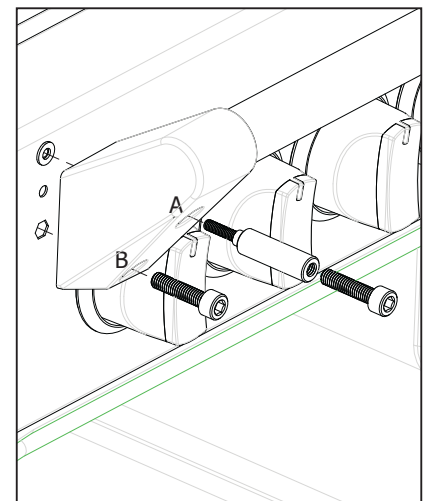

Installing Your Cooker

Stabilising and Securing

Your cooker may come with a stability chain, if it does not we recommend that you buy a stability bracket from your local supplier, this will keep the cooker from moving and will prevent damage to the flexible hosing at the back of the cooker.

Your stability chain

Your cooker must be secured to a wall or a solid partition behind the cooker.

Your stability bracket

You can buy a stability bracket from your supplier and it can fitted as follows:

- Place the cooker in position and draw a pencil line level with the front edge.
- Remove the cooker and mark off 450mm from the pencil line to locate the front edge of the lower bracket.
- Fix the bracket to the floor. Measure from floor level to engagement edge in the back of the cooker and add 3mm.
- Assemble the underside of the top part of the bracket to this height.
- See the drawings for the location of the bracket and the recommended positioning.

Levelling

Once your cooker is secure:

Place a spirit level onto a baking tray, on an oven shelf. These cookers are fitted with adjustable feet which will allow you to adjust the height of the appliance until it is level. The adjustable feet are at the rear of the cooker.

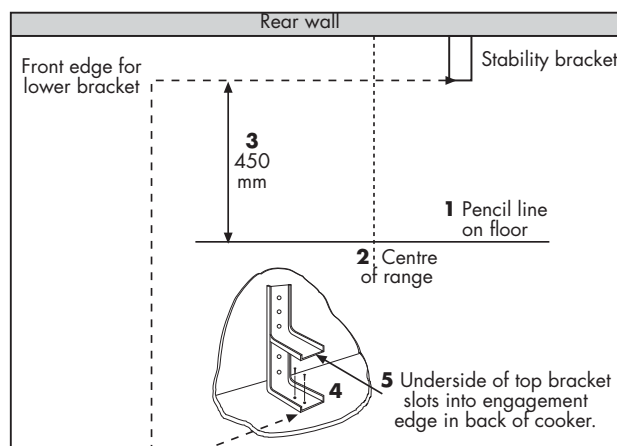
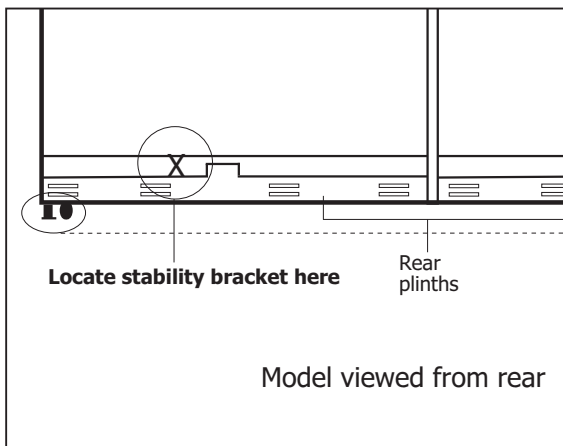
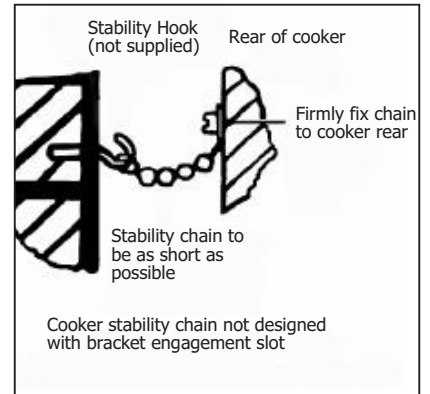

Installing Your Cooker

Connecting the electricity supply

For Australia:

For your own safety we recommend that your cooker be installed by a competent person. The cooker should be installed in accordance with AS/NZS 3000:2000

We recommend that this appliance is connected by a competent person, who is a member of a recognised "Competent Persons Scheme" and who will comply with the I.E.E. and local regulations.

The appliance must be installed using a multi-pole control unit of 30 Ampere minimum capacity with 3mm minimum separation at all poles.

Ensure that you route all mains electrical cables well clear of any adjacent heat source, such as an oven or grill.

- Where a fixed connection is used, a device allowing the appliance to be isolated on all poles from the mains supply with a contact opening width of at least 3mm must be provided.
- After connection to the electricity please check that all electrical parts are working.
- The maximum power rating is specified in the Technical Data section of this handbook, and also on the Data Badge on the appliance.

- This appliance must be fitted using a double pole unit of 30 ampere minimum capacity with 3mm minimum contact at all poles.
- Access to the mains terminal is gained by opening the terminal block cover at the rear of the appliance - use a flat bladed screw driver for this.
- Connection should be made with a 6.0mm² twin and earth cable.
- First strip the wires. then push the cable through the cable clamping the terminal block cover.
- Connect the cable to the terminal block and tighten the cable clamp screw - see diagram.
- Close the terminal box, ensuring that the cover is engaged on the locking tabs.
- Sufficient cable should be used to allow the cooker to be pulled out, but must hang clear of the floor so it does not become twisted or trapped when the cooker is pushed back.

Warning:
This appliance must be earthed!

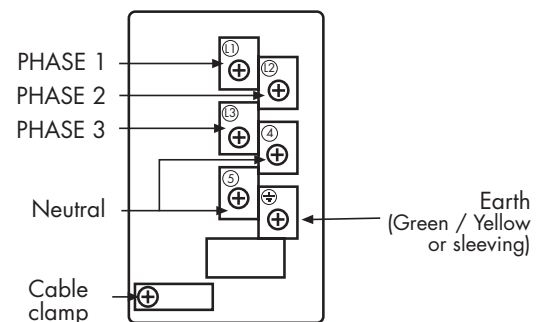

Installing Your Cooker

Connecting to the gas supply

The inlet to the appliance is ISO 7 - Rp $\frac{1}{2}$ " internal thread situated towards the top right corner of the rear.

Fit the bayonet connection. This should be located so as to ensure that the flexible hose does not kink.

Use a 900mm - 1125mm length of flexible hose.

Ensure that all pipe work is of the correct rating.

Natural Gas - Flexible connections should comply with BS 669. Parts of the appliance likely to come into contact with a flexible connector have a temperature of less than 70 °C.

LP Gas - For flexible connections use a bayonet type hose, suitable for use on LP Gas up to 50mbar pressure rise and 70 °C temperature rise. The flexible hose should be coloured black with a red stripe, band or label. If in doubt, contact your supplier.

After installation make sure all connections are gas sound.

Commissioning

Pressure settings:

G20 Natural Gas @ 20mbar

G30 Butane @ 28-30mbar

G31 Propane @ 37mbar

Hob

Turn on gas supply and check for soundness at the hot-plate injector. Light two burners and check that the pressure is correct.

Grill

Turn the control knob to the full on position and ignite, allow the grill to operate for a few minutes.

Oven

Turn the control knob to the full on position and ignite, allow the oven to operate for a few minutes.

Installing Your Cooker

Connecting to the gas supply

Means of isolation shall be provided at the shut off point by either an approved quick connect device or a Type 1 manual shut off valve. The outlet of the quick connect device shall be at, or below, the horizontal position.

Connection to the gas supply should be made using the Aquaknect AS/NZS 1869 class B hose assembly with an internal diameter of not less than 10mm (supplied with the appliance) and regulator (regulator for use with natural gas)

NOTE: Maximum length of hose 900mm.

The temperature rise of the areas at the rear of the cooker that are likely to come into contact with the flexible hose do not exceed 70°C.

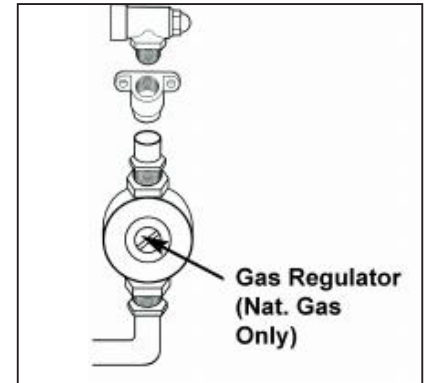

Ventilation requirements

Ventilation must be as specified by AS5601 Installation code. The room containing the appliance should have an air supply.

An appliance should be installed in a location for complete combustion of gas, proper flueing and to maintain ambient temperature of the immediate surrounding at safe limits, under normal conditions.

LP Gas only - Do not install this appliance in a room below ground level. This does not preclude installation into rooms which are basements with respect to one side of the building, but open to ground level on the opposite side.

Failure to install appliances correctly is dangerous and could lead to prosecution.

After installation make sure all connections are gas sound.

Commissioning

Pressure settings:

Natural Gas - 1.0 kPa

Butane - 2.75 kPa

Propane - 2.75 kPa

Hob

Turn on gas supply and check for soundness at the hot-plate injector. Light two burners and check that the pressure is correct.

Technical Data - Notes

Europe & Russia

Type of gas:

Natural Gas I_{2H}

Natural Gas II_{2H3+}*

LP Gas I₃₊

Please see your data badge for specified gas type.

* Can be converted from Natural gas to LP Gas

Never attempt to convert an appliance - unless the data badge states that you can.

Burner Aeration:

Fixed

Pressure setting:

G20 Natural Gas @ 20mbar

G30 Butane @ 28-30mbar

G31 Propane @ 37mbar

G30 Butane @ 50mbar

G31 Propane @ 50mbar

G25 Natural Gas @ 25mbar

Electrical supply:

230V / 400V 3N ~ 50Hz

All elements are rated at 230V

Countries of destination:

Great Britain

Ireland

France

Holland

Germany

Russia

Belgium

Australia

Type of gas:

Please see data badge your for specified gas type. * Can be converted from Natural gas to LP Gas

Never attempt to convert an appliance - unless the data badge states that you can.

Burner Aeration:

Fixed

Pressure setting:

Natural Gas - 1.0 kPa

Butane - 2.75 kPa

Propane - 2.75 kPa

Electrical supply:

230V / 400V 3N ~ 50Hz

All elements are rated at 230V

Countries of destination:

Australia

Technical Data - Notes

Fuel Type	Hotplate Burner / Element	Nominal Rate Qn	Butane g/h	Propane g/h	Injectors used
Natural Gas	Hob - small	1.0kW	-	-	77
	Hob - medium	2.0kW	-	-	104
	Hob - Large	3.0kW	-	-	129
	Hob - wok	3.5kW	-	-	121 & 63
	Total heat input				
	●5 burners	11.5kW			
	●7 burners	14.5kW			
LP Gas	Hob - small	1.0kW	73	72	50
	Hob - medium	2.0kW	145	143	70
	Hob - Large	3.0kW	218	215	87
	Hob - wok	3.5kW	254	250	87 & 35
	Total heat input				
	●5 burners	11.5kW			
	●7 burners	14.5kW			

Fuel Type	Dual Variable grill (90 & 100 size)	Dual Variable grill (110 size)	Multifunction oven (all)	Fanned oven (all)
Electric @ 230V	1.6 - 2.5kW	1.6 - 2.6kW	2.3kW	2.3kW
Slow cook oven (if fitted)	Oven lamps			
0.16kW	25W each			
Appliance size	90cm	100cm	110cm	
Maximum load	7200W	7370W	7465W	

Technical Data - Notes

Australian hob / hotplate - Technical Data

Fuel Type	Hotplate Burner / Element	Nominal Rate Qn	Butane g/h	Propane g/h
Natural Gas	Hob - small	3.6MJ/h	-	-
	Hob - medium	7.2MJ/h	-	-
	Hob - Large	10.8MJ/h	-	-
	Hob - wok	12.6MJ/h	-	-
	Total heat input ●7 burners	51.5MJ/h	-	-
LP Gas	Hob - small	3.8MJ/h	-	-
	Hob - medium	7.2MJ/h	-	-
	Hob - Large	10.2MJ/h	-	-
	Hob - wok	12.6MJ/h	-	-
	Total heat input ●7 burners	52.0MJ/h	-	-

Conversion Instructions

This conversion kit is for use on the following appliances:

Dual Fuel - all sizes.

This conversion kit is to be used to convert the above appliances from:

UK Appliance Nat Gas to LP - Natural Gas G20 @ 20mbar to LPG G30/31 @ 29/37mbar

UK Appliance LP to Nat Gas - LPG G30/31 @ 29/37mbar to Natural Gas G20 @ 20mbar

UK to German LPG G30/G31 @ 50 mbar

UK to Australian NG @ 1.0kPa

UK to Australian ULPG @2.75kPa

Before beginning conversion, ensure that the Gas and Electricity supplies have been turned off. The full conversion must be completed - i.e. you must change the injectors **and** the by-pass pins.

Important: The conversion procedure must be carried out by a suitably qualified person i.e. Corgi registered. After conversion all affected parts must be checked for gas soundness.

Injectors & Bypass Screws

UK / Europe NG					
Hotplate burner	Auxiliary (Small)	Semi Rapid (Medium)	Rapid (Large)	Wok	
				Inner	Outer
Injector	77	104	129	63	121

UK / Europe LP (Excluding Germany)					
Hotplate burner	Auxiliary (Small)	Semi Rapid (Medium)	Rapid (Large)	Wok	
				Inner	Outer
Injector	50	70	87	35	87

Germany LP					
Hotplate burner	Auxiliary (Small)	Semi Rapid (Medium)	Rapid (Large)	Wok	
				Inner	Outer
Injector	46	61	79	35	77

Australian NG					
Hotplate burner	Auxiliary (Small)	Semi Rapid (Medium)	Rapid (Large)	Wok	
				Inner	Outer
Injector	82	118	142	72	138
Bypass	63	63	77		

Australian ULPG					
Hotplate burner	Auxiliary (Small)	Semi Rapid (Medium)	Rapid (Large)	Wok	
				Inner	Outer
Injector	50	70	87	35	87
Bypass	32	39	45	80	

Conversion Instructions

To convert the hotplate burners

- a) Remove the pan supports
- b) Remove the burner caps and burner heads
- c) Unscrew the existing injectors from the hotplate burner bowls
- d) Replace with the injectors supplied in the conversion kit as detailed in the tables on the previous page.

Note: when converting the wok burner, it is necessary to replace the two injectors, the inner and outer. The outer injector is visible on removal of the cover plate.

UK / Europe / Russia

To convert the gas tap bypass screws

- a) Remove the hotplate control knobs springs and bezels
- b) Using a small flat bladed screwdriver, each bypass screw can be accessed via the hole in the inner fascia panel
- c) NG to LP - Turn each bypass screw fully clockwise until it stops.
Do not over tighten
- d) LP to NG – Turn each bypass screw anti-clockwise until a small, stable flame is maintained when the control is turned to simmer.
The flame must not be extinguished when wafted.
- e) Refit the control bezels, springs and control knobs.

Conversion labels

Conversion to LP (excluding Germany)

After conversion, affix the label supplied with the conversion kit
PER/FOR G30/G31 adjacent to the appliance data badge

Conversion LP Germany

After conversion, affix the label supplied with the conversion kit
PER/FOR G30/31@50mbar adjacent to the appliance data badge

Conversion to NG

After conversion, affix the label supplied with the conversion kit
PER/FOR G20 adjacent to the appliance data badge

Australian Conversion Instructions

UK to Australia NG / ULPG

To convert the hotplate bypass screws

- a) Remove the hotplate control knobs, springs and bezels
- b) Using a small, flat bladed screwdriver, each bypass screw can be accessed via the hole in the inner fascia panel
- c) Undo the bypass screw by turning in an anti-clock wise direction, when fully un-screwed the bypass screw can be removed using a pair of long nosed pliers.
- d) Replace with the bypass screws supplied in the conversion kit as detailed in the tables on the previous page
- e) Turn the bypass screw fully clockwise until it stops. Do not over tighten.

Conversion labels

Conversion to Australian NG

After conversion, add the label stating "ONLY FOR USE WITH NATURAL GAS" adjacent to the appliance gas inlet.

Conversion to Australian LP

After conversion, add the label stating "ONLY FOR USE WITH PROPANE GAS" adjacent to the appliance gas inlet.

Service Record

Please record your model number and serial number in the space below.

Where are my model and serial numbers?

- Freestanding HL appliances: base of storage drawer
- Freestanding appliances: front frame near oven cavity
- Built in oven: front frame near oven cavity
- Hobs: base plate of the hob

Having these numbers to hand will help us to help you, quickly and more efficiently. When contacting us, please use the Customer Care number on the back cover of this handbook.

Model Number									
Serial Number									

Date of purchase	Installer stamp / Printed name	Date of installation
Place of purchase:		

Date	Part(s) replaced	Engineers Stamp/ Printed Name

Wiring colour code: Bk-Black, Bn-Brown, Bu-Blue, Gn-Green, Or-Orange, R-Red, W-White, Y-Yellow, Gy-Grey, V-Violet

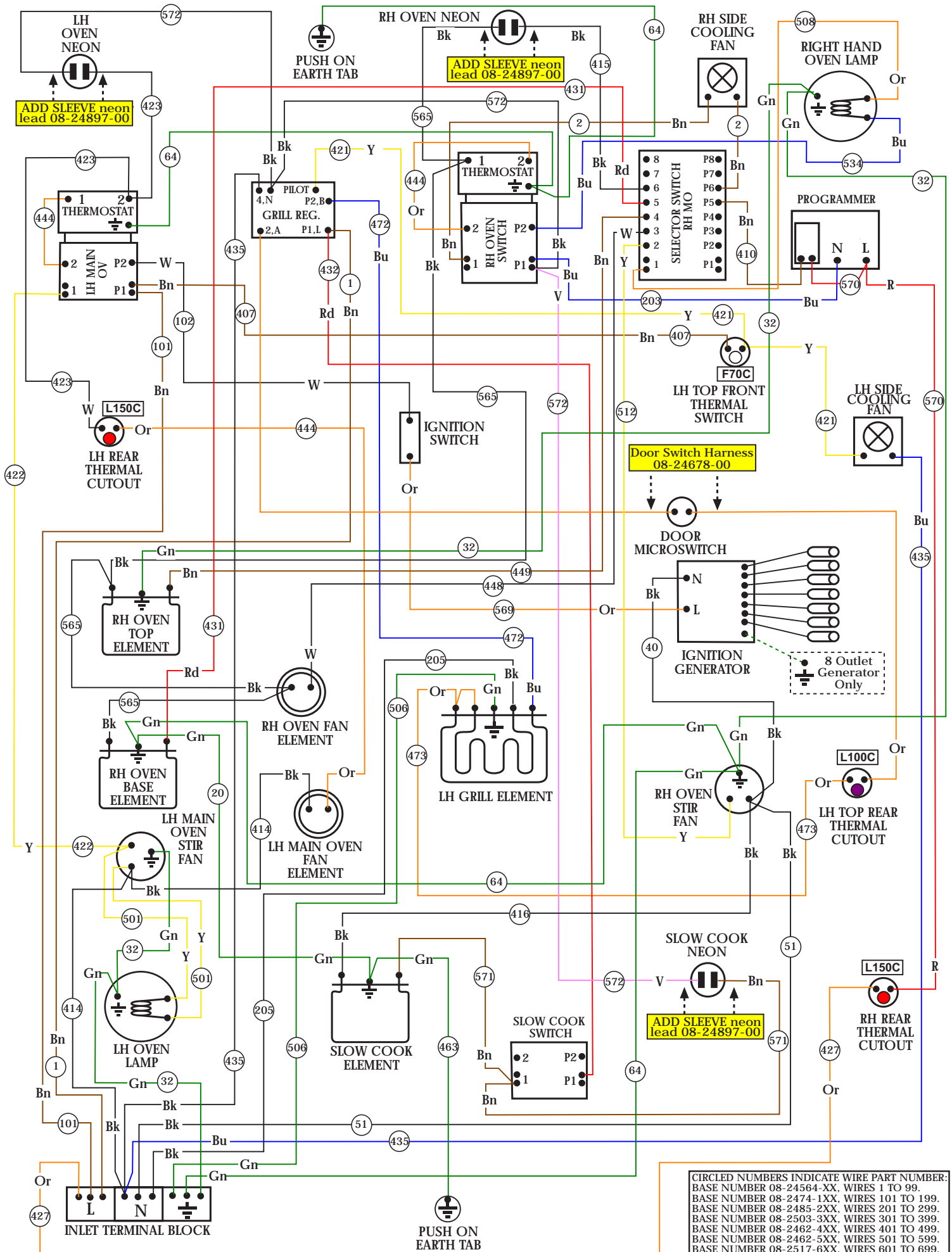

CIRCLED NUMBERS INDICATE WIRE PART NUMBER:
 BASE NUMBER 08-24564-XX. WIRES 1 TO 99.
 BASE NUMBER 08-2474-1XX. WIRES 101 TO 199.
 BASE NUMBER 08-2485-2XX. WIRES 201 TO 299.
 BASE NUMBER 08-2503-3XX. WIRES 301 TO 399.
 BASE NUMBER 08-2462-4XX. WIRES 401 TO 499.
 BASE NUMBER 08-2462-5XX. WIRES 501 TO 599.
 BASE NUMBER 08-2517-6XX. WIRES 601 TO 699.



BELLING 110DF

HOTPLATE ASSEMBLY

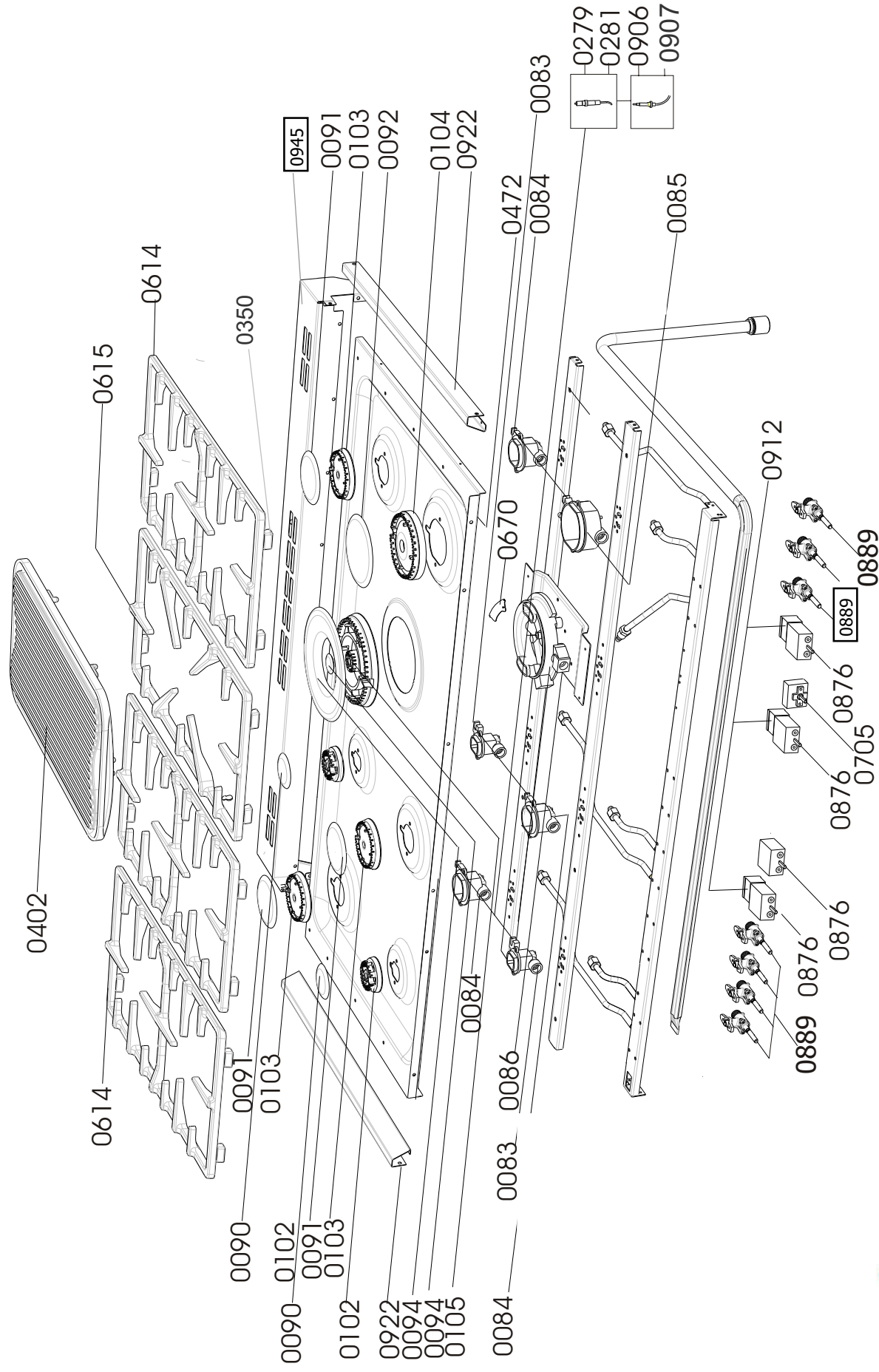



110DF

DOORS, FASCIA, AND FRONT FRAME ASSEMBLY

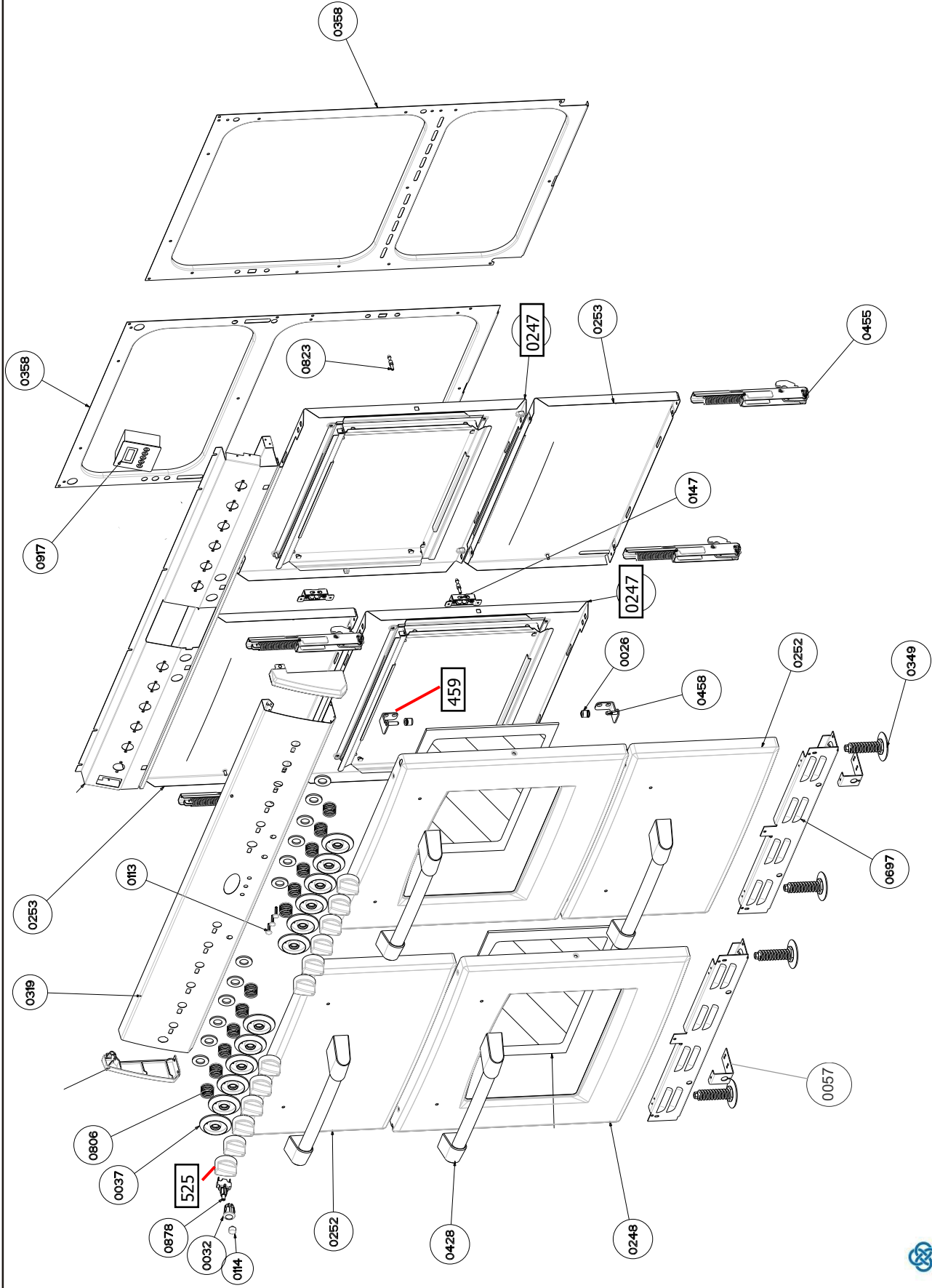



110DF

CAVITY ASSEMBLY

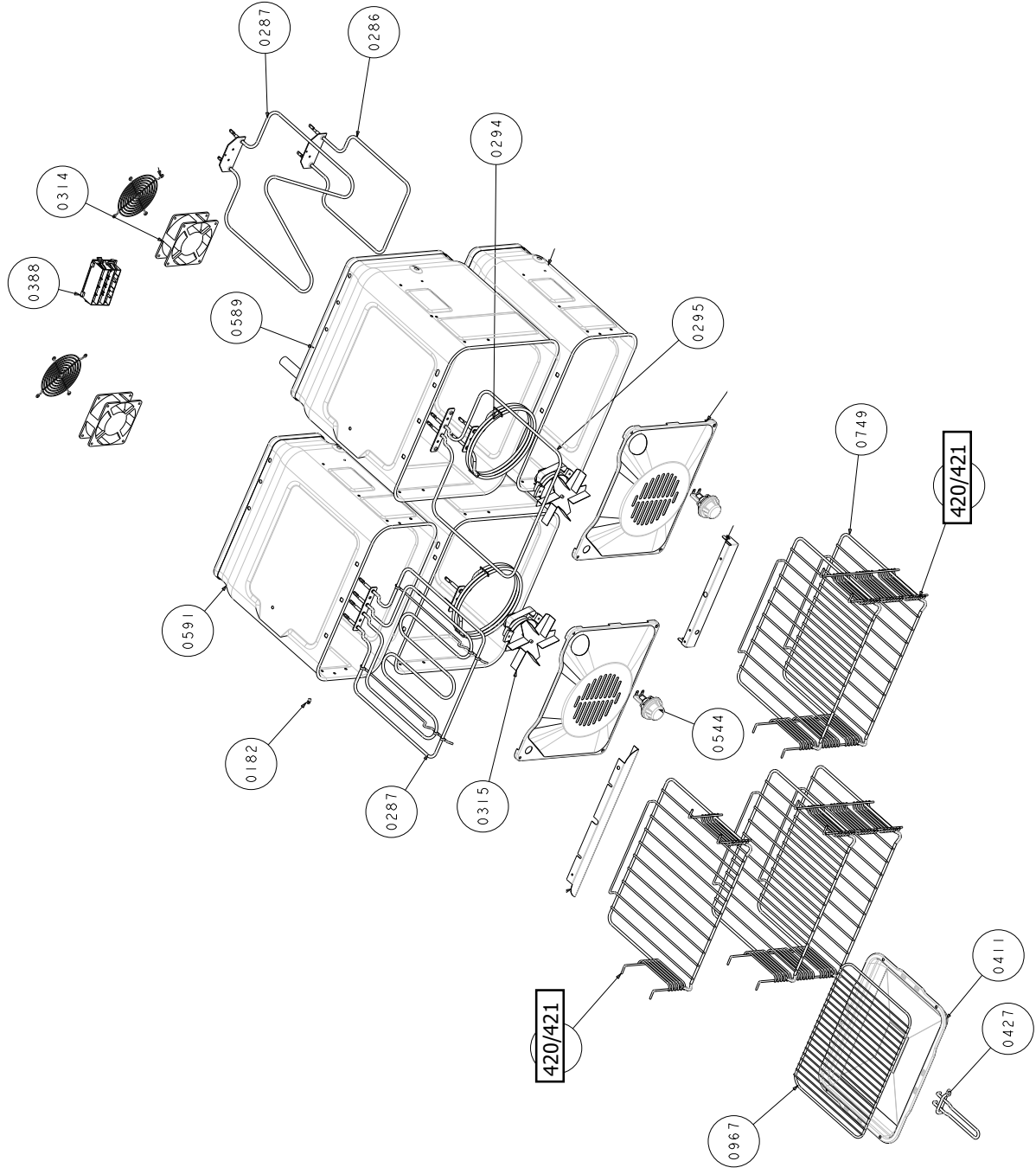

PRODUCT: BELLING K'SINGTON 110DF-IN blk
 COLOUR: Black
 CODE: 444449062
 ISSUE:
 DATE:

RANGE



Key	Product	Product Description	TCO	Replace	Date	Qty
026	082060800	BEARING door KB				2
026	082060800	BEARING door KB				2
032	082566100	BEZEL switch Blk				1
0358	602925403	FRONTFRAME 55 std mot				1
0358	602925402	FRONTFRAME 55 std mot	19/03/09			1
037	082851722	BEZEL energy regulator Nic				1
037	082851704	BEZEL grill Sta	18/06/09			1
037	082851721	BEZEL multifunction switch Nic				1
037	082851703	BEZEL mf switch Sta	15/06/09			1
037	082851706	BEZEL slow cook Sta	15/06/09			1
037	082851724	BEZEL slow cook/warmer Nic				1
037	082851720	BEZEL t/stat fanned Nic				1
037	082851702	BEZEL tstat elec fanned Sta	22/06/09			1
037	082851719	BEZEL t/stat multifunction Nic				1
037	082851701	BEZEL tstat elec mf Sta	15/06/09			1
037	082851718	BEZEL h/p Nic				7
037	082851700	BEZEL h/p Sta	29/06/09			7
040	083029901	BLOCK terminal PA223Sn/6				1
057	502895700	BRACKET plinth				1
057	502895700	BRACKET plinth				1
0813	502925501	STRUT stiffener 55	23/01/09			2
0813	502925501	STRUT stiffener 55	19/03/09			1
083	082519300	BURNERBOWL aux (0.77) Defendi				2
084	082519400	BURNERBOWL semi (1.04) Defendi				3
085	082519500	BURNERBOWL rapid (1.29)Defendi				1
086	082546707	BURNERBOWL wok ng(63/121) tc				1
090	082957800	BURNERCAP aux (serie3)blk gls				2
091	082957801	BURNERCAP semi (serie3)blk gls				3
092	082957802	BURNERCAP rapid(serie3)blk gls				1
094	082546900	BURNERCAP wok inner-gloss				1
094	082547000	BURNERCAP wok outer-gloss				1
102	082957700	BURNERSKIRT aux (serie 3)				2
103	082957701	BURNERSKIRT semi (serie 3)				3
104	082957702	BURNERSKIRT rapid (serie 3)				1
105	082546801	BURNERSKIRT wok				1
108	081586001	BUSH cavity support				2
108	081586001	BUSH cavity support				2
108	081586001	BUSH cavity support				2
108	081586001	BUSH cavity support				2
113	081718425	BUTTON timer Blk				3
114	082566200	BUTTON switch Nic				1
147	082533800	CATCH roller (nylon)				1
147	082533800	CATCH roller (nylon)				1
178	082520000	CLIP spring Defendi				7
182	082101600	CLIP tubular				4
182	082101600	CLIP tubular				4
182	082101600	CLIP tubular				4
206	531805900	FLUE oven assy				1
207	562802005	COVER PLINTH inner 110 blk	12/08/2008			1
207	562895813	COVER plinth 110 blk				1
210	602598709	FANCOVER 60 flue lamp mot				1
210	602598709	FANCOVER 60 flue lamp mot				1
211	082291500	COVER flue vent				1

PRODUCT: BELLING K'SINGTON 110DF-IN blk
 COLOUR: Black
 CODE: 444449062
 ISSUE:
 DATE:

RANGE



Key	Product	Product Description	TCO	Replace	Date	Qty
247	012561015	DOOR INNER 55 main rh assy mot				1
0249	602561006	DOOR INNER 55 main win lh mot				1
0396	082894400	GLASS outer door Ranges				1
0398	082894501	GLASS inner rg 50/55 main ken				1
247	012561015	DOOR INNER 55 main rh assy mot	20/04/09			1
0249	602561006	DOOR INNER 55 main win lh mot	99/99/99			1
0396	082894400	GLASS outer door Ranges	99/99/99			1
0398	082894501	GLASS inner rg 50/55 main ken	99/99/99			1
247	012561014	DOOR INNER 55 main lh assy mot	09/09/2009			1
0249	602561006	DOOR INNER 55 main win lh mot	99/99/99			1
0396	082894400	GLASS outer door Ranges	99/99/99			1
0398	082894501	GLASS inner rg 50/55 main ken	99/99/99			1
247	012561014	DOOR INNER 55 main lh assy mot				1
0249	602561006	DOOR INNER 55 main win lh mot				1
0396	082894400	GLASS outer door Ranges				1
0398	082894501	GLASS inner rg 50/55 main ken				1
248	562859015	DOOR OUTER 55 main w rh be gbl				1
248	562859014	DOOR OUTER 55 main w lh be gbl				1
252	562858907	DOOR OUTER 55 top be gbl				1
252	562858907	DOOR OUTER 55 top be gbl				1
253	601823319	DOOR INNER 55 top mot				1
253	601823319	DOOR INNER 55 top mot				1
279	082547100	ELECTRODE wok 900mm long lead				1
281	082532602	ELECTRODE 1300mm DEL703				6
286	082230600	ELEMENT base KB	12/01/2008			1
286	082354202	ELEMENT base slow cook 160w	27/04/09			1
287	082971200	Element gr/dual 20.35715.000				1
287	082971900	Element ov/top 20.35721.000				1
287	081561400	ELEMENT grill dual KB	12/01/2008			1
293	082971800	Element base 20.35726.000				1
293	082971500	Element base 20.35729.000				1
294	081561600	ELEMENT oven fan (2.5kw) KB	12/01/2008			1
294	082971300	Element oven fan 20.35718.000	18/05/09			1
294	082971302	ELEMENT oven fan 20.35719.010				1
294	082971300	Element oven fan 20.35718.000	18/05/09			1
294	082971302	ELEMENT oven fan 20.35719.010				1
294	081561600	ELEMENT oven fan (2.5kw) KB	12/01/2008			1
295	082010701	ELEMENT oven top KB	04/06/2009			1
314	082233400	FAN cooling DP203A-2123LST-C31				1
314	082233400	FAN cooling DP203A-2123LST-C31				1
315	081581800	FAN oven circulation				1
315	081581800	FAN oven circulation				1
319	012848654	FACIA assy be ken 110dfin blk				1
0299	082848100	ENDCAP facia lh Blk				1
0300	082848102	ENDCAP facia rh Blk				1
349	081830501	FOOT levelling long				2
349	081830501	FOOT levelling long				2
388	082825101	GENERATOR ignition DG441				1
402	082554901	GRIDDLE ribbed universal				1
410	082469100	GRIP handle grill pan				1
411	082517700	GRILL PAN (vit enamel) Blk	23/03/09			1
411	602517700	GRILLPAN std mot				1
411	602517700	GRILLPAN std mot				1
411	082517700	GRILL PAN (vit enamel) Blk	23/03/09			1
418	502975400	GUARD wiring				1
420	082917304	GUIDE shelf large lh 1978				1
420	082917304	GUIDE shelf large lh 1978				1
420	082917300	GUIDE shelf small lh 1974				1
421	082917305	GUIDE shelf large rh 1979				1
421	082917301	GUIDE shelf small rh 1975				1

PRODUCT: BELLING K'SINGTON 110DF-IN blk
 COLOUR: Black
 CODE: 444449062
 ISSUE:
 DATE:

RANGE



Key	Product	Product Description	TCO	Replace	Date	Qty
421	082917305	GUIDE shelf large rh 1979				1
424	082738101	HANDBOOK Bell 900/1100DF Int				1
424	082738100	HANDBOOK Bell 900/1100DF range	18/03/09			1
427	082283705	HANDLE grill pan 1041				1
428	082851800	HANDLE assy door Chr				1
428	082851800	HANDLE assy door Chr				1
428	082851800	HANDLE assy door Chr				1
428	082851800	HANDLE assy door Chr				1
455	082905900	HINGE drop down door (Zan)				2
455	082905900	HINGE drop down door (Zan)				2
458	082856400	HINGE bottom				1
458	082856400	HINGE bottom				1
459	082856401	HINGE top				1
459	082856401	HINGE top				1
472	502582513	HOTPLATE 110 gas fsd sta				1
5044	082606772	BELLING BADGE BBELLING013				1
0522	012860205	KIT conversion rg lpg aus				1
525	082830202	KNOB gas h/p o universal Blk				12
544	926016900	LAMP assy oven				1
544	926016900	LAMP assy oven				1
557	082044000	LOCKNUT foot				2
574	082930600	NEON SL332250010T				3
580	082938800	NUT flanged locking				6
614	082843600	PANSUPPORT cast be				3
615	082843601	PANSUPPORT cast be wok				1
697	562044129	PLINTH 55 blk	22/01/09			1
697	562044129	PLINTH 55 blk	22/01/09			1
697	562988200	PLINTH 110 blk				1
705	082590900	REGULATOR energy MPA-V02SV				1
728	080180676	SCREW m6x30 pp mc				2
728	080180676	SCREW m6x30 pp mc				2
728	080215764	WASHER fibre 11/64" dia				2
728	080180676	SCREW m6x30 pp mc				2
728	080215764	WASHER fibre 11/64" dia				2
728	080180676	SCREW m6x30 pp mc				2
733	081797201	SEAL grill KB				1
733	081797201	SEAL grill KB				1.3
734	081797200	SEAL main ov 550HL KB				1.5
734	081797200	SEAL main ov 550HL KB				0.3
734	081797200	SEAL main ov 550HL KB				1.5
736	081423974	SEAL tap 4mm COPRECI F3862-04				7
738	080180734	SCREW m4x12 tt pcsk ch blk				4
738	080180734	SCREW m4x12 tt pcsk ch blk				4
749	082917403	SHELF main oven 452 wide 1970				2
749	082917403	SHELF main oven 452 wide 1970				1
749	082917403	SHELF main oven 452 wide 1970				2
791	082554300	SPACER oven fan				3
791	082554300	SPACER oven fan				3
791	082554300	SPACER oven fan				2
806	081511001	SPRING COMPRESSION CONTROL BZ				12
823	082494402	STRIKER door (silver)				1

PRODUCT: BELLING K'SINGTON 110DF-IN blk
 COLOUR: Black
 CODE: 444449062
 ISSUE:
 DATE:

RANGE



Key	Product	Product Description	TCO	Replace	Date	Qty
823	082494402	STRIKER door (silver)				1
835	082963200	Counter support				2
835	082963200	Counter support				2
876	082578200	SWITCH door ROLD				1
878	081811101	SWITCH ignition E2009				1
878	082859700	SWITCH selector 42.08000.041				1
879	082859800	SWITCH on/off 42.07900.008				1
880	082808901	SWITCH thermal L100c				1
880	081545403	SWITCH thermal cut-out 150c				2
881	082558101	SWITCH m/ov 42.02400.008				2
882	082808902	SWITCH thermal fan				1
888	082964501	TAP semi 0.32 bp lh set 0.46				2
889	082964500	TAP aux 0.27 bp lh set 0.46				2
890	082964603	TAP wok 0.68 bp rh set 1.07				1
894	082964601	TAP semi 0.32 bp rh set 0.46				1
895	082964602	TAP rapid 0.40 bp rh set 0.60				1
906	082965800	thermocouple wok				1
909	082938701	Thermocouple 500mm long				3
910	082938700	Thermocouple 300mm short				3
912	082558001	THERMOSTAT EGO 55.17069.090				2
917	082874000	TIMER (programmer 900)	24/11/08			1
917	082966600	TIMER (prog)EL143/ESK1457-001				1
922	562586711	HOTPLATE SIDE 110 blk				2
945	562586611	VENT TRIM 110 st blk				1
945	562851911	VENT TRIM 110 be blk	17/04/09			1
950	562867306	EXTRUSION facia rg 110 lip blk				1
967	082518800	WIRE TRIVET grill pan 1130				1
991	030116310	WHEEL assy				1



**GLEN DIMPLEX
AUSTRALIA PTY LTD**

BELLING

RICHMOND 110 DF

**REPAIR
AND
MAINTAINANCE**

PROCEDURES



IMPORTANT

**BEFORE CARRYING
OUT ANY SERVICING
WORK ALWAYS
DISCONNECT FROM
THE ELECTRICAL
SUPPLY**

1) REMOVING THE MAIN OVEN DOORS



REMOVE THE 2 SCREWS FROM THE UPPER HINGE AS INDICATED.
 REMOVE THE UPPER HINGE AND LIFT THE DOOR UPWARDS AWAY FROM THE LOWER HINGE
 ENSURE THAT THE DOOR IS SUPPORTED AT ALL TIMES TO STOP EXCESSIVE DISTORTION TO THE LOWER HINGE PIN

2) REMOVING THE GRILL/SLOW OVEN DOOR

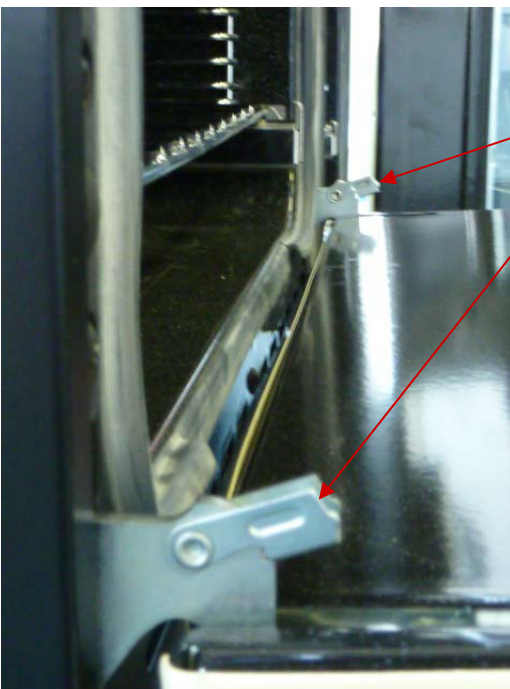

OPEN THE DOOR FULLY
 RELEASE THE 2 CLIPS AND PUSH FULLY BACK INTO POSITION SHOWN
 CLOSE DOOR TO REST POSITION AND LIFT TO REMOVE DOOR AND HINGE
 WHEN REPLACING ENSURE THAT HINGES ARE FULLY ENGAGED IN THE HINGE BUSH

REMOVING THE HINGE FROM THE DOOR

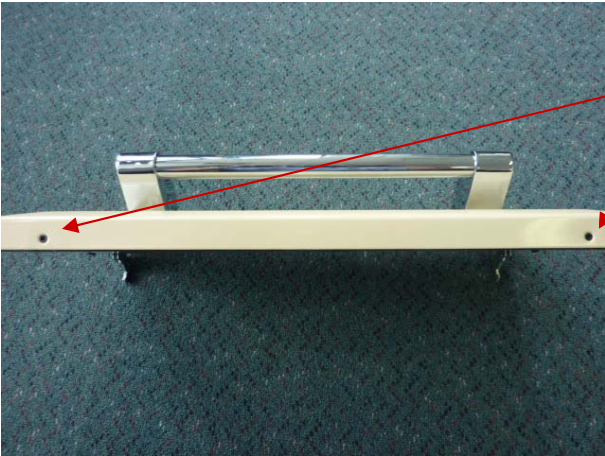

REMOVE THE 6 SCREWS
AROUND THE DOOR EDGE TO
SPLIT THE INNER PANEL FROM
THE OUTER PANEL

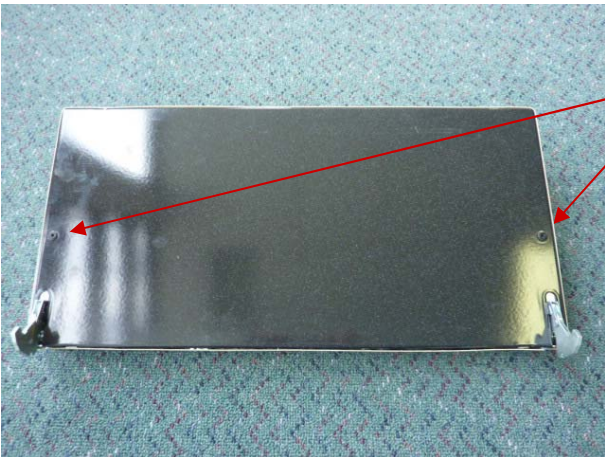

REMOVE 2 X SCREWS ON THE
INNER DOOR PANEL AND 2
SCREWS AT THE BOTTOM OF THE
PANEL TO REMOVE THE HINGE
FROM THE INNER DOOR PANEL

3) REMOVAL OF THE HOTPLATE

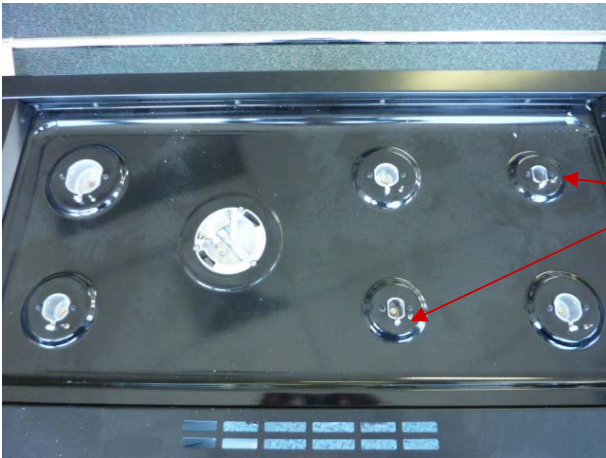

REMOVE ALL PAN SUPPORTS
AND HOB BURNERS

REMOVE 15 X SCREWS
SECURING THE BURNERS TO
THE HOB TOP

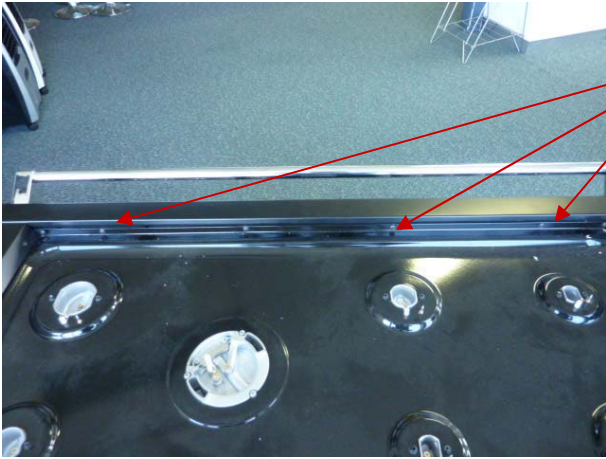

REMOVE 6 X SCREWS AT THE
REAR OF THE FACIA PANEL AS
SHOWN

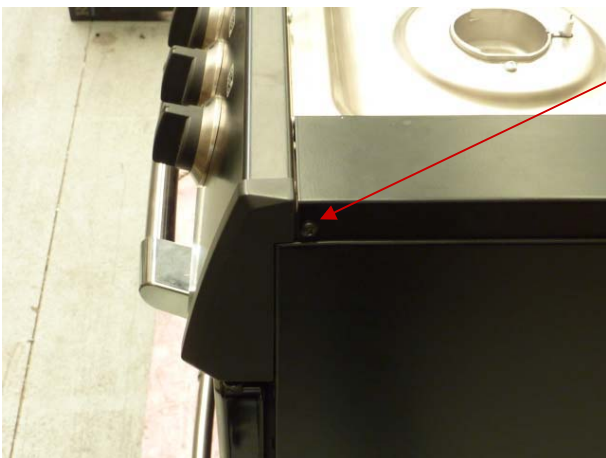

REMOVE 2X SCREWS ONE
EITHER SIDE AS SHOWN

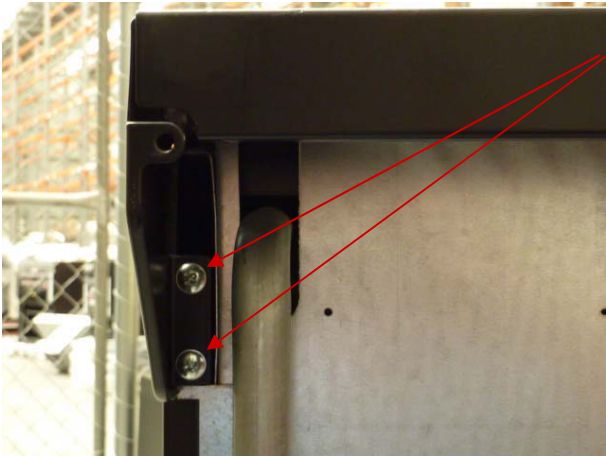

REMOVE 4 X SCREWS (2 EITHER SIDE) AS SHOWN THAT SECURES THE VENT TRIM

THE HOB TOP COMPLETE WITH THE SIDE TRIMS AND REAR VENT PLATE CAN NOW BE REMOVED FROM THE APPLIANCE BY LIFTING UPWARDS

HOTPLATE REMOVED

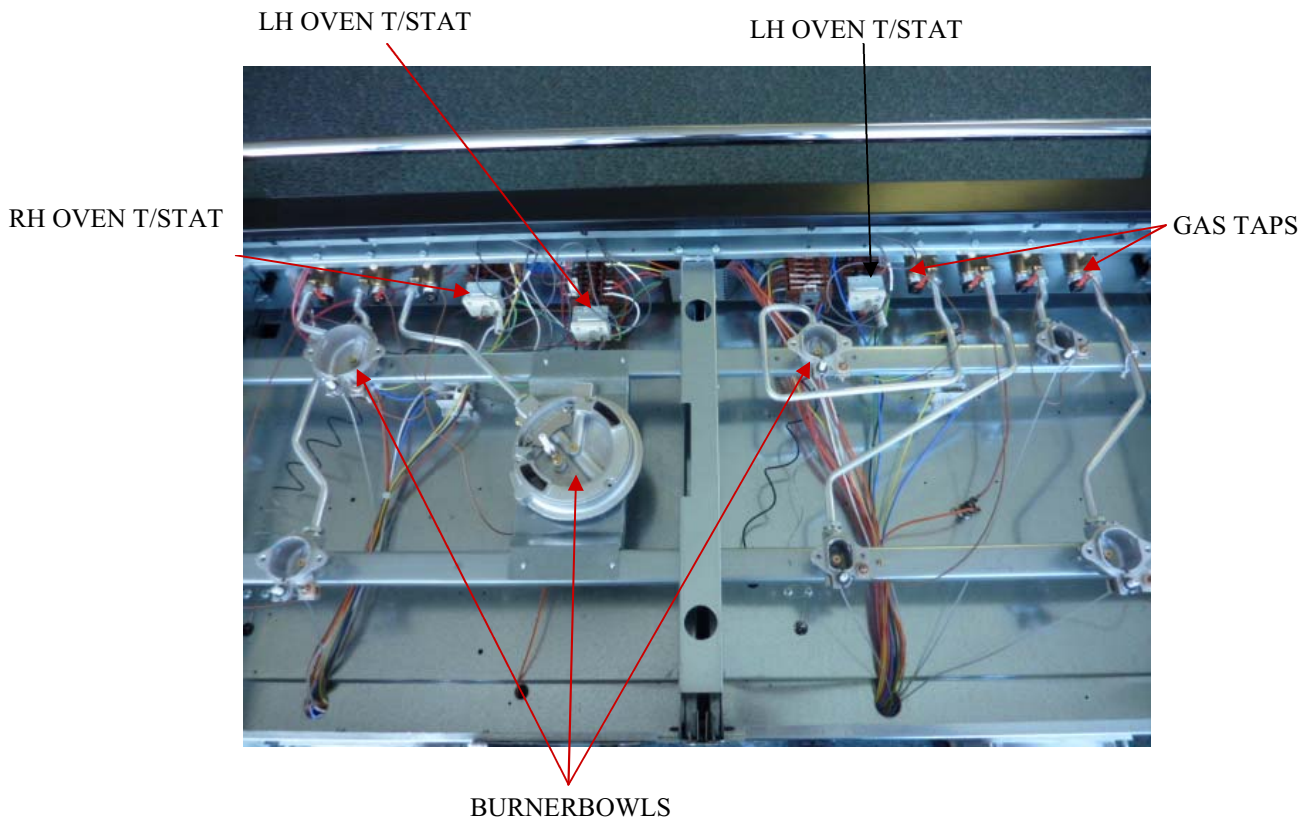

4) REMOVAL OF SIDE PANELS

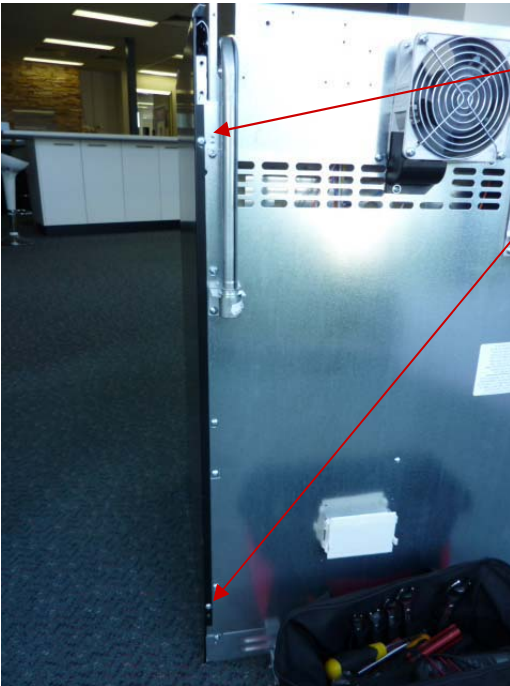

REMOVE 2X SCREWS AT REAR OF APPLIANCE

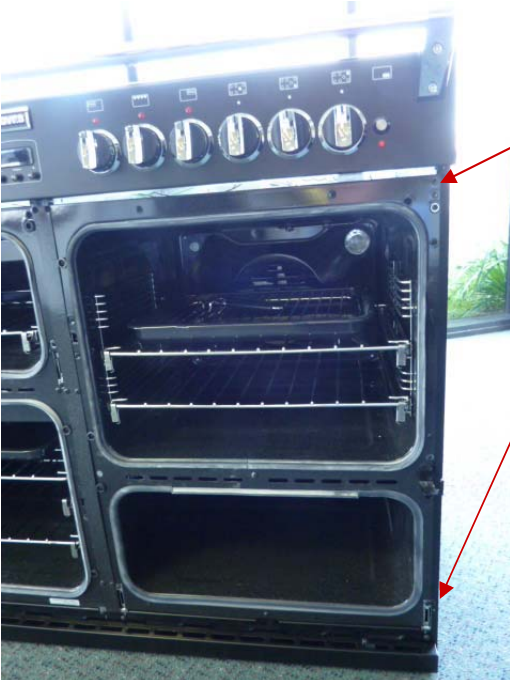

REMOVE 2X SCREWS FROM FRONT OF APPLIANCE

REMOVE SIDE PANEL

5) REMOVAL OF FACIA PANEL

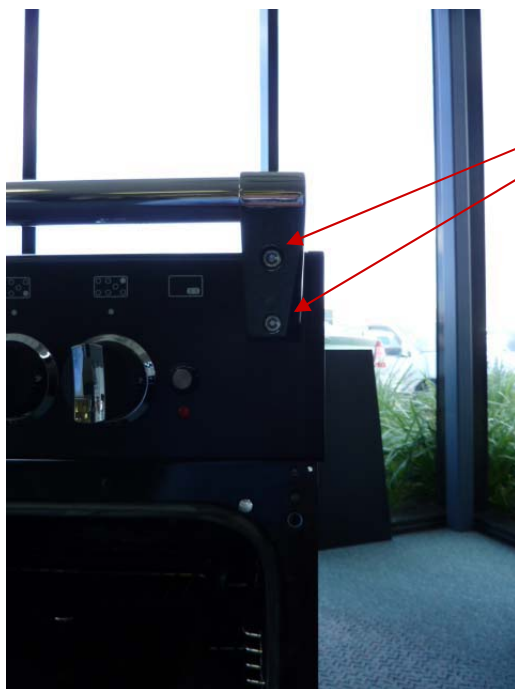

REMOVE THE TOWEL RAIL BY
REMOVING THE 4 HEX BOLTS
USING 5mm ALLEN KEY

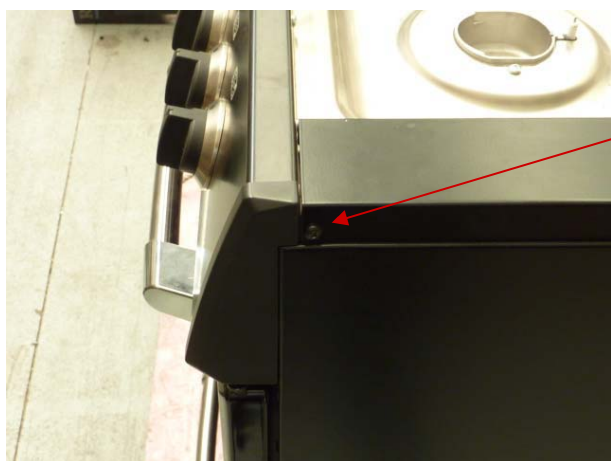

REMOVE THE 2 SCREWS (ONE EI-
THER SIDE) THAT SECURE THE
HOTPLATE TO THE FACIA

REMOVE ALL THE CONTROL
KNOBS



REMOVE THE 2 SCREWS SECURING THE SIDE PANEL AND GENTLY EASE THE SIDE PANEL BACK

REMOVE THE LOWER FACIA SECURING SCREW AND PULL THE FACIA PANEL AWAY

6) REAR SERVICE PANELS

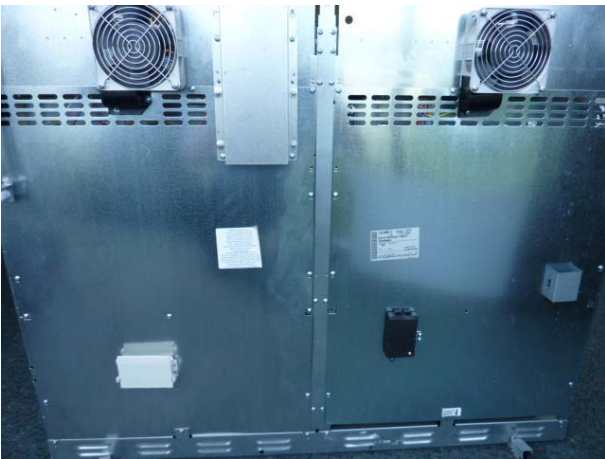

REMOVE ALL SECURING SCREWS TO REMOVE COMPLETELY DISCONNECT ALL WIRING FROM THE IGNITION GENERATOR AND TERMINAL BLOCK

REAR SERVICE PANEL REMOVED

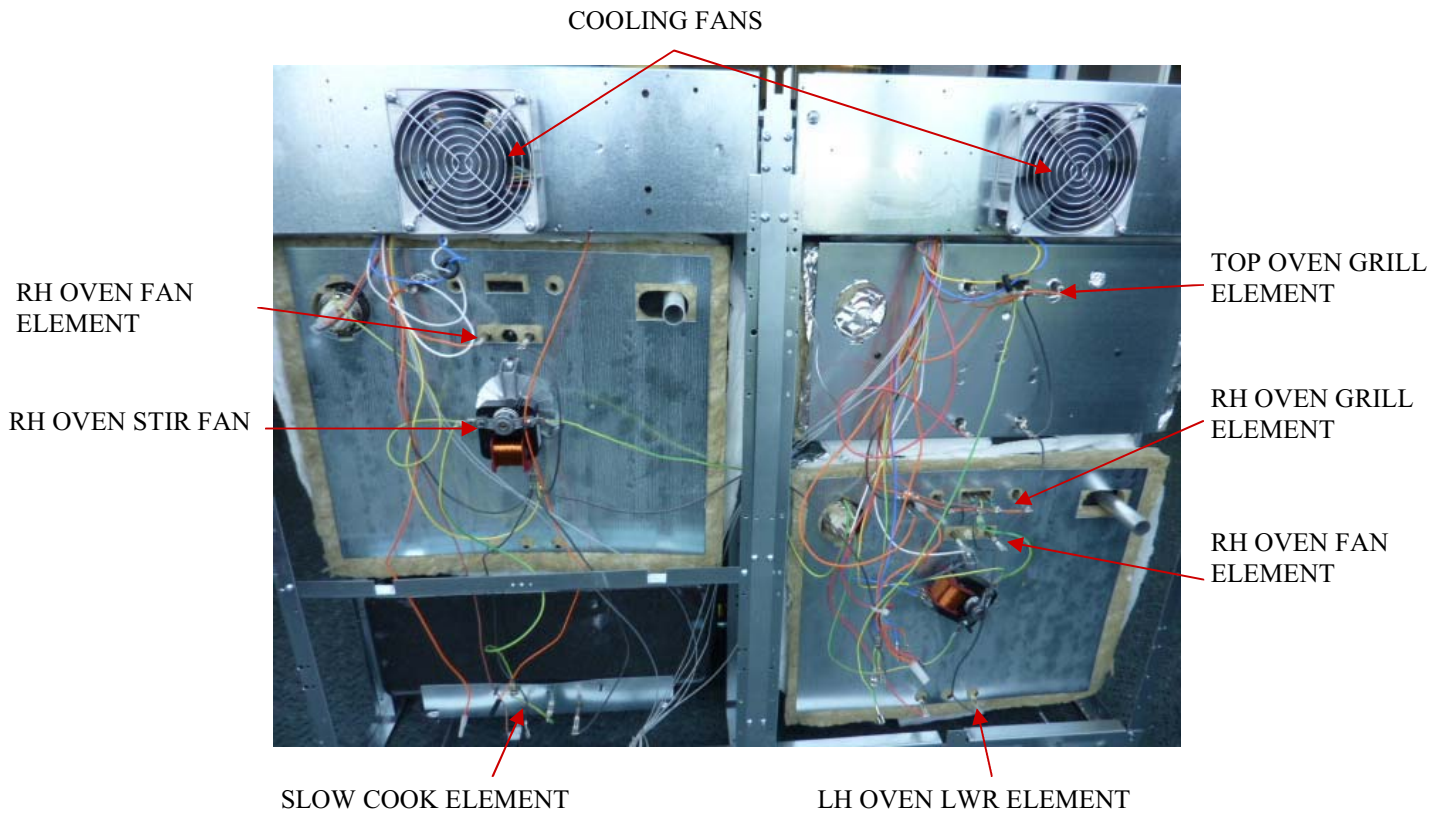

7) DOOR SEALS



THE DOOR SEAL IS REMOVED BY JUST PULLING IT IS SECURED IN THE GAP BETWEEN THE CAVITY AND FRONTFRAME AND REQUIRES NO OTHER FIXING

TO REFIT PUSH IN ALWAYS ENSURE THAT DOOR SEAL LIP IS FACING THE CORRECT WAY

REPLACEMENT OF COMPONENTS

A) ELECTRODES



FOLLOW STEP 3 AND REMOVE THE HOB TOP
 REMOVE ELECTRODE CLIP BY SQUEEZING TOGETHER AND PULLING TO REMOVE
 REMOVE ELECTRODE FROM BURNER BOWL AND IGNITION LEAD FROM IGNITION GENERATOR
 ON REPLACING ALWAYS ENSURE THAT THE RUBBER WASHER IS

B) HOB THERMOCOUPLES

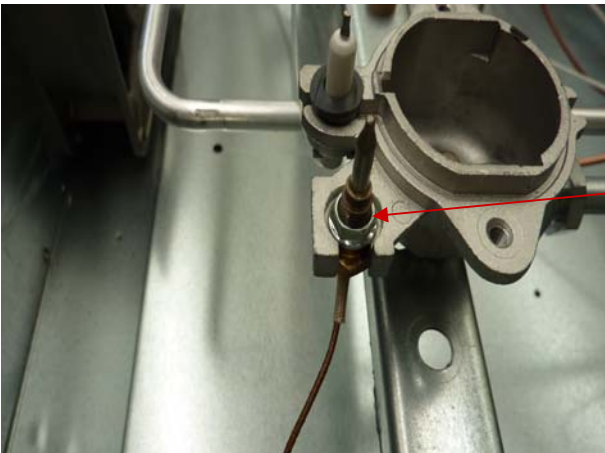

FOLLOW STEP 3 AND REMOVE THE HOB TOP

REMOVE UPPER NUT USING A 7mm SPANNER
 REMOVE THE THERMOCOUPLE FROM THE BURNERBOWL AND GAS TAP

ON REPLACING ALWAYS ENSURE THAT THE RUBBER WASHER IS REPLACED TO REDUCE DISTURBANCE TO THE FLAME DUE TO THE COOLING FAN

C) GAS TAPS

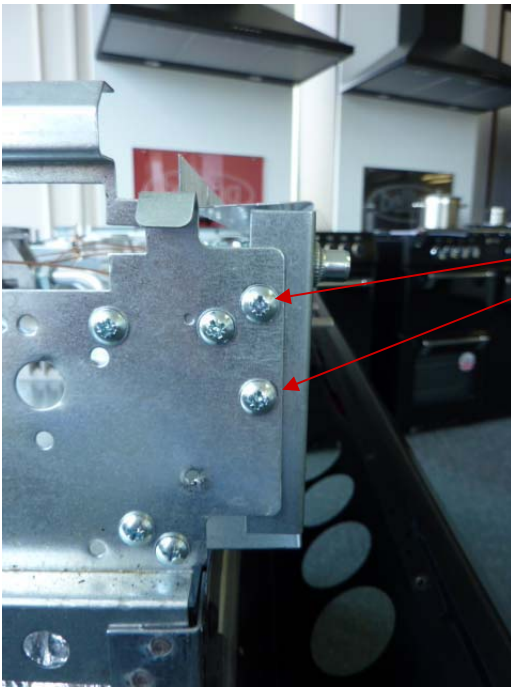

FOLLOW STEPS 3/5 AND REMOVE THE HOTPLATE AND FACIA PANEL
REMOVE 2 SCREWS AS SHOWN ON EITHER SIDE TO RELEASE THE INNER FACIA PANEL

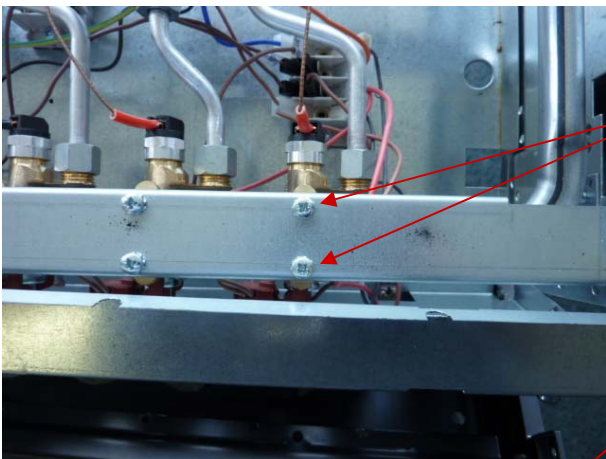

PULL FORWARD INNER FACIA PANEL TO GAIN ACCESS TO THE 2 X TAP SECURING SCREWS

UNDO BUNDY TUBE CONNECTION AND REMOVE

DISCONNECT THERMOCOUPLE

REMOVE 2 GAS TAP SECURING SCREWS AND REMOVE THE TAP

WHEN REPLACING TAP ALWAYS ENSURE THAT A NEW TAP WASHER IS FITTED (part number 081423974)

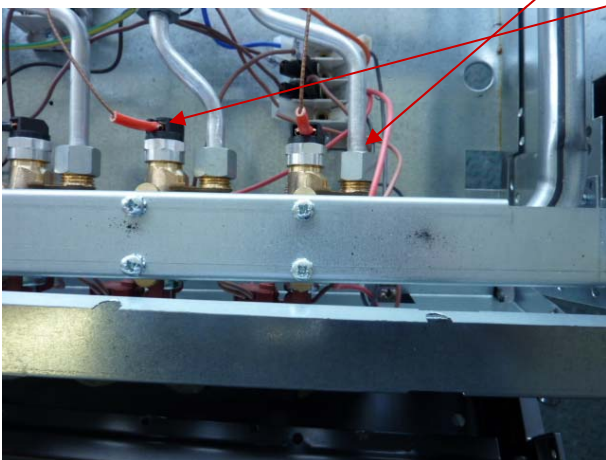

D) COOLING FANS

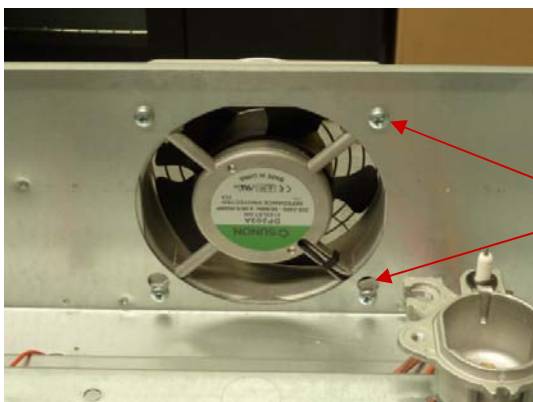

FOLLOW STEP 3 AND REMOVE THE HOTPLATE

REMOVE THE 4 X SECURING SCREWS AS SHOWN AND REMOVE THE COOLING FAN

E) THERMOSTATS

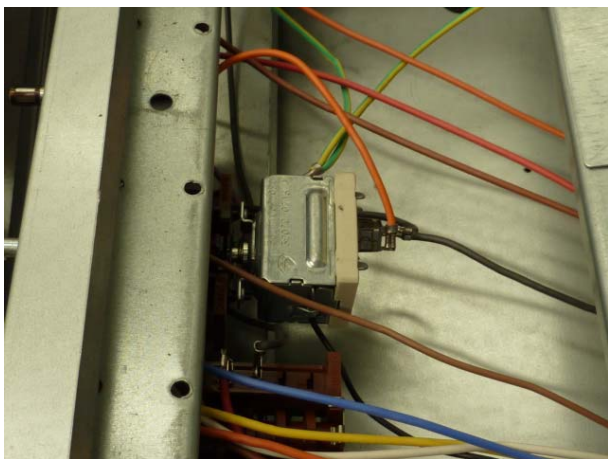

FOLLOW STEP 3 AND REMOVE THE HOTPLATE

PULL THE THERMOSTAT FROM THE BACK OF THE SWITCHPACK AND REMOVE THE PHIAL FROM THE RELEVANT OVEN

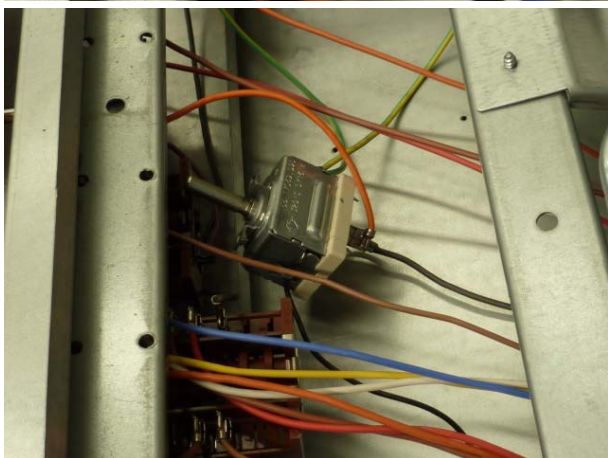

F) TIMER

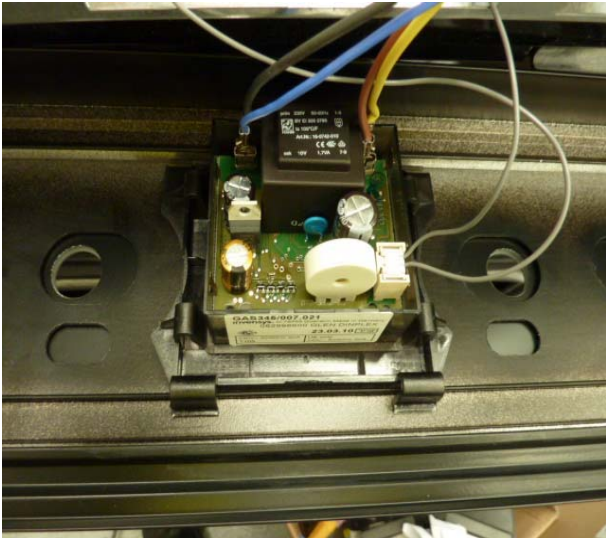

FOLLOW STEP 5 REMOVE FACIA PANEL

RELEASE TIMER FROM HOLDING CLIPS BY GENTLY PUSHING IN CLIPS WITH A SCREWDRIVER

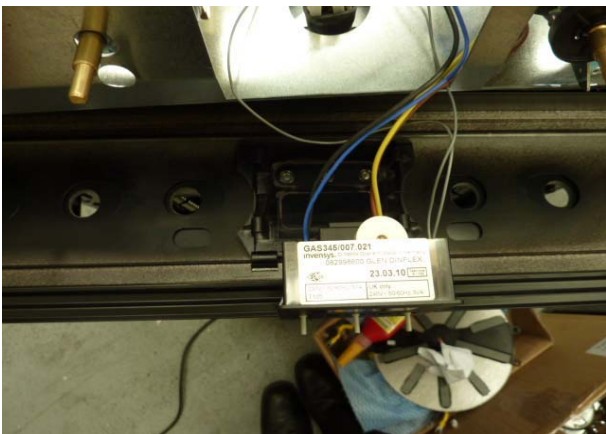

G) SELECTOR SWITCHES

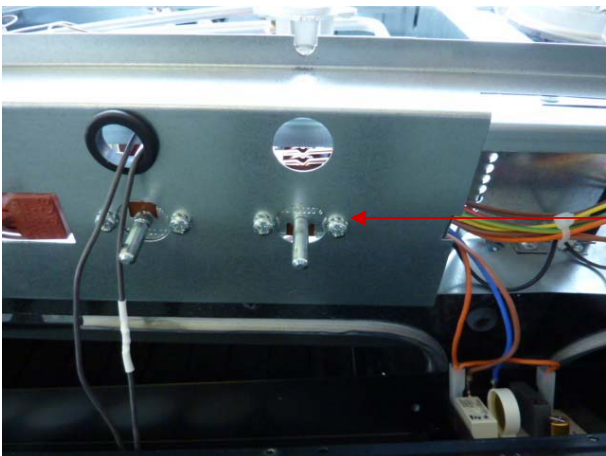

FOLLOW STEP 3/5 AND REMOVE THE HOTPLATE AND FACIA PANEL

REMOVE THE 2 SECURING SCREWS AND PULL THE SELECTOR SWITCH FROM THE APPLIANCE

H) IGNITION MICROSWITCHES

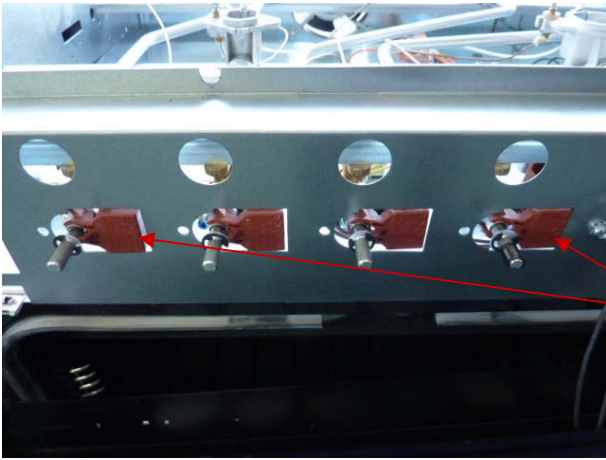

FOLLOW STEP3/5 AND REMOVE
THE HOTPLATE AND FACIA
PANEL
PULL THE INNER FACIA PANEL
FORWARD TO GAIN ACCESS

GENTLY PRIZE THE SWITCHES
FROM THE GAS TAPS

N.B THE SWITCHES CANNOT BE EXCHANGED INDIVIDUALLY THEY
MUST BE CHANGED AS A COMPLETE SET

I) LH TOP OVEN GRILL ELEMENT



FOLLOW STEP 6 AND REMOVE THE REAR SERVICE PANEL

DISCONNECT WIRES

REMOVE GRILL ELEMENT GUARD BY LOOSENING 2 HIDDEN SCREWS (POSITIONS INDICATED) AND SLIDING OFF



REMOVE THE 2 SCREWS SECURING THE ELEMENT BRACKET TO THE CAVITY AND PULL THE ELEMENT FORWARD TO REMOVE

J) LH OVEN FAN ELEMENT

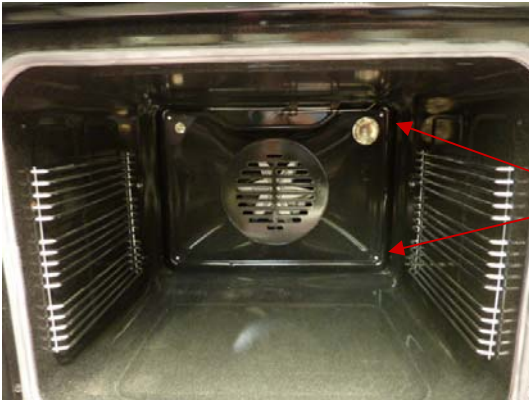

FOLLOW STEP 6(AND REMOVE THE REAR SERVICE PANEL

REMOVE 4 X REAR FAN COVER SECURING SCREWS AND REMOVE FAN COVER

DISCONNECT WIRING

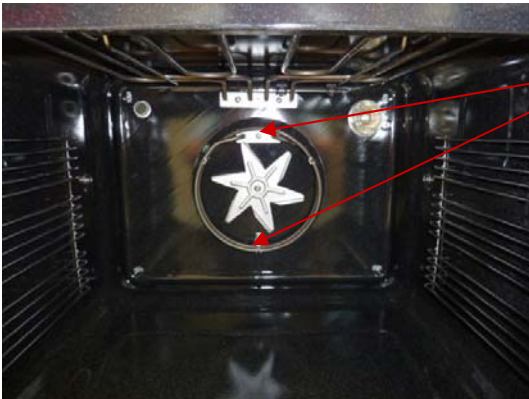

REMOVE THE 2 ELEMENT SECURING SCREWS AND PULL ELEMENT FORWARD INTO THE CAVITY

K) LH OVEN STIR FAN

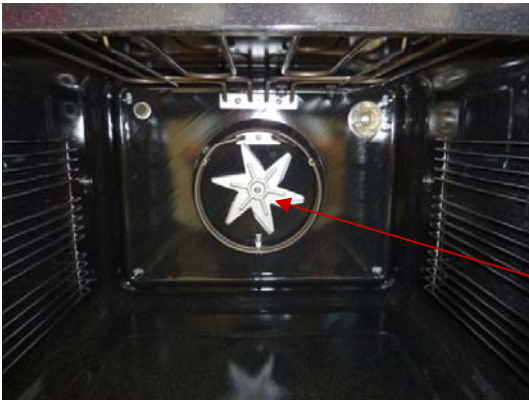

FOLLOW STEP 6(PAGE 6) AND REMOVE THE REAR SERVICE PANEL

REMOVE THE REAR FAN COVER AS ON PREVIOUS PAGE

REMOVE THE FAN IMPELLOR
N.B L/H THREAD NEEDS TO TURNED
CLOCKWISE TO REMOVE

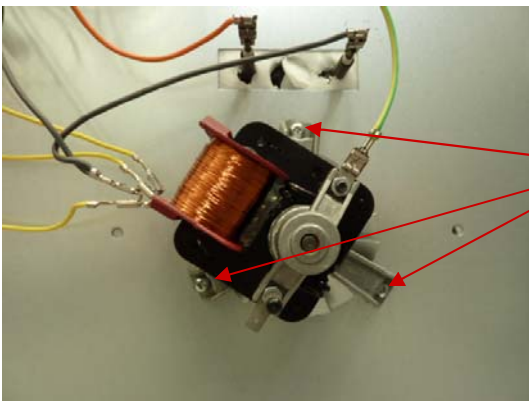

DISCONNECT WIRING FROM FAN

REMOVE 3 X STIR FAN SECURING
SCREWS AND REMOVE FAN FROM
THE REAR OF THE APPLIANCE

L) MAIN OVEN LIGHT FITTING

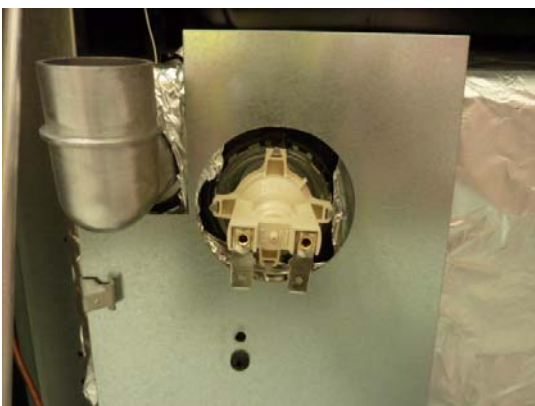

FOLLOW STEP 6 (PAGE 6) REMOVING
REAR SERVICE PANEL
REMOVE GLASS LAMP COVER BY
UNSCREWING
REMOVE THE EARTH LEAD
RELEASE 4 XCLIPS HOLDING LIGHT
FITTING IN PLACE
REMOVE BY PULLING LIGHT FITTING
FORWARD INTO CAVITY

M) RH OVEN STIR FAN AND ELEMENT

REMOVED AS PER L/H OVEN

N) R/H OVEN UPPER ELEMENT

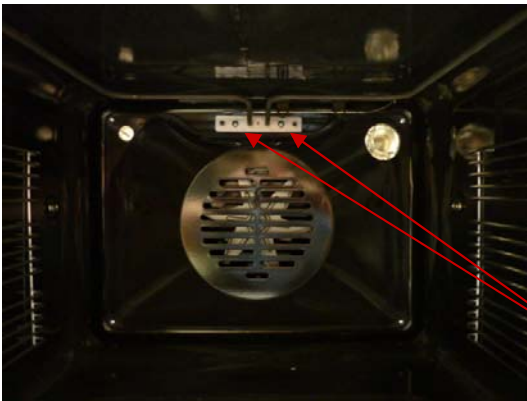

REMOVE THE REAR SERVICE PANEL

DISCONNECT THE WIRING

REMOVE THE ELEMENT GUARD AS PER GRILL ELEMENT REMOVAL

REMOVE THE 2X SECURING SCREWS AND PULL AND REMOVE THE ELEMENT FROM THE CAVITY

O) R/H OVEN LOWER ELEMENT

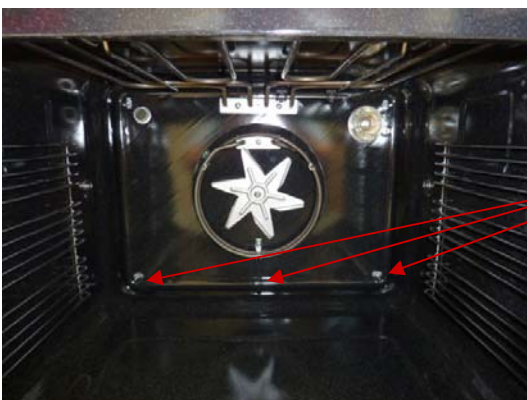

FOLLOW STEP 6 AND REMOVE THE REAR SERVICE PANEL

REMOVE REAR FAN COVER

REMOVE 3X SECURING SCREWS FROM INSIDE THE CAVITY

WITHDRAW THE ELEMENT FROM THE REAR

P) SLOW COOKER ELEMENT



FOLLOW STEP 6 AND REMOVE THE REAR SERVICE PANEL

DISCONNECT THE WIRING

REMOVE THE 3 SCREWS FROM INSIDE THE CAVITY

REMOVE THE ELEMENT FROM THE REAR

Q) DOOR HANDLES

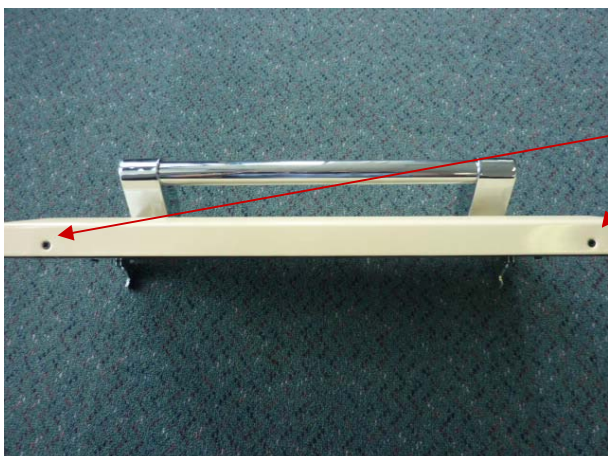

REMOVE THE DOOR FROM THE APPLIANCE

REMOVE 6X SCREWS FROM THE OUTER SIDE OF THE PANEL

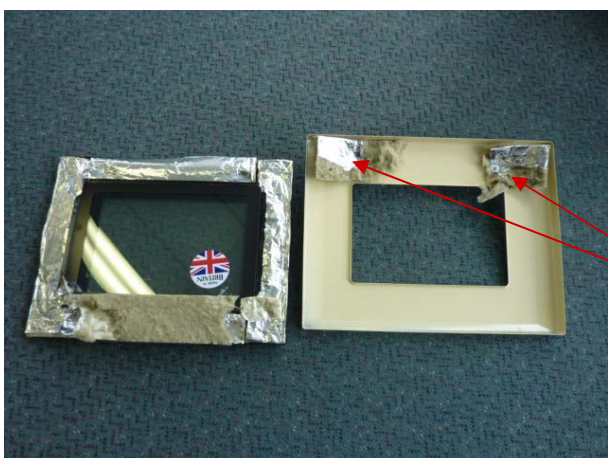

WITH THE SECURING SCREWS REMOVED THE INNER PANEL CAN NOW BE SEPARATED FROM THE OUTER PANEL

THE DOOR HANDLE IS SECURED BY 2 SCREWS

TECHNICAL SPECIFICATIONS

NOMINAL RESISTANCES AT 20oC

GRILL ELEMENT INNER	31.3 Ω	2800W
OUTER.....	55.6 Ω	
R/H OVEN LOWER ELEMENT.....	51 Ω	1000W
R/H OVEN GRILL ELEMENT.....	31 Ω	2900W
R/H OVEN FAN ELEMENT.....	28.1 Ω	2300W
L/H OVEN FAN ELEMENT.....	28.1 Ω	2300W
SLOW COOKER ELEMENT.....	322 Ω	160W
MAIN OVEN STIR FAN.....	63.5 Ω	
COOLING FAN.....	1.81k Ω	

THERMAL CUT-OUTS

TOP.....	L120°C
REAR.....	L150°C
FAN RUN-ON.....	F60°C



GLEN DIMPLEX
AUSTRALIA PTY LTD

BELLING

RICHMOND

110DF

FAULTFINDING
GUIDES



Single Electric Cooker Main Fan oven not working

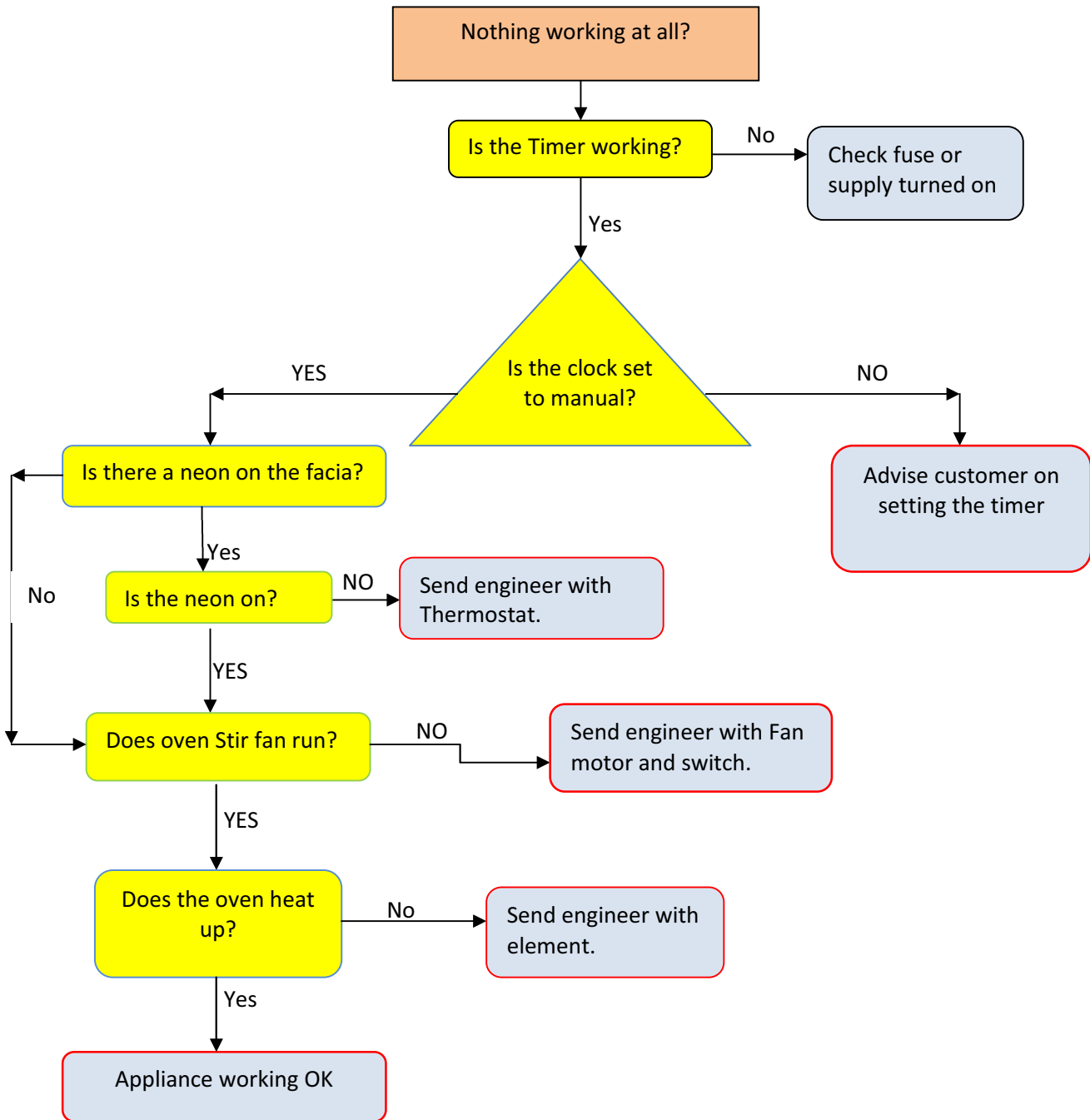

Electric Multi function oven Main oven not working

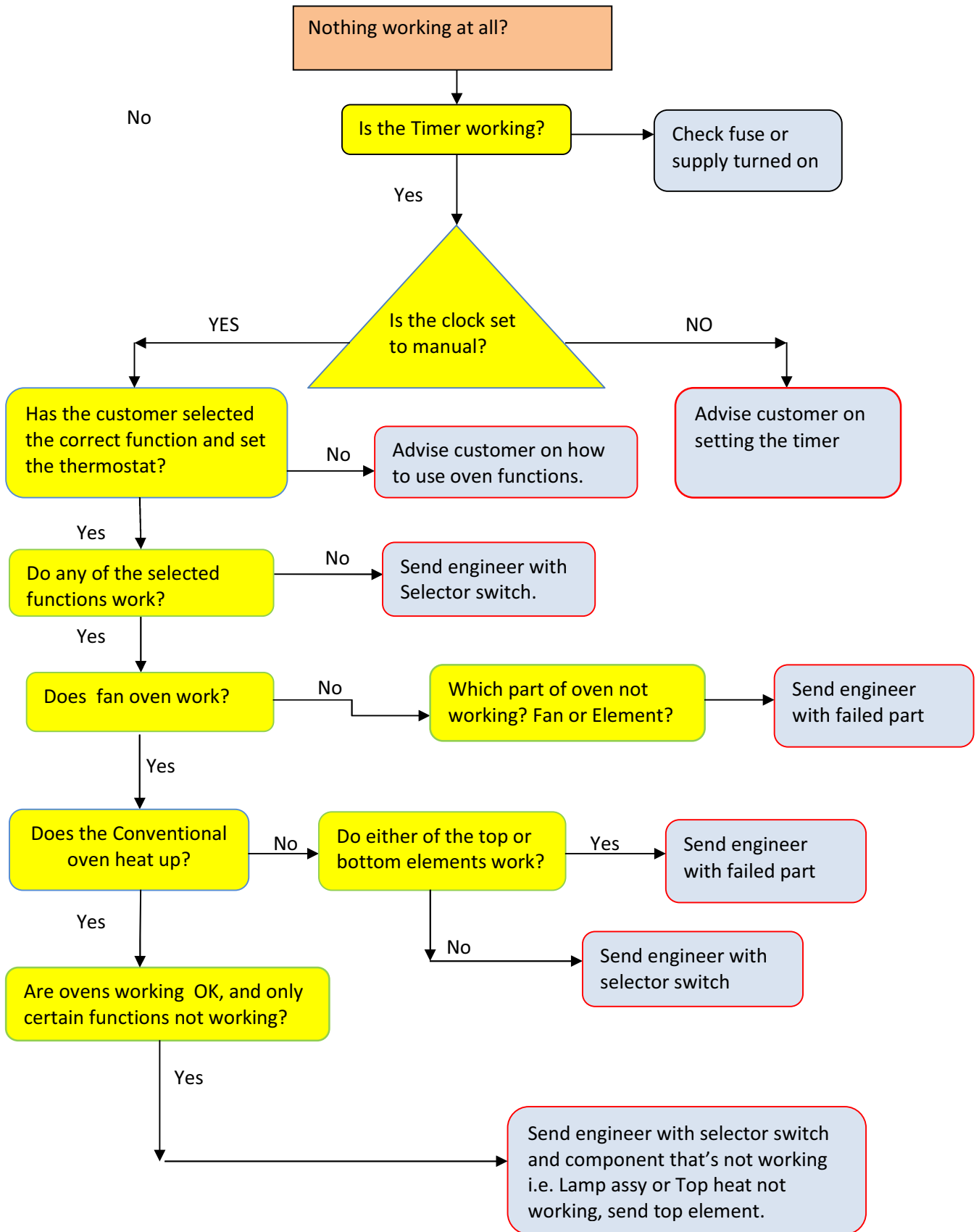

Gas Hob
Faulty ignition (Automatic ignition)
Customer states no ignition to burner/s

